

WARNING

- Use of non-Midway parts or circuit modifications may cause serious injury or equipment damage!
- Federal copyright, trademark and patent laws protect this game. Unauthorized modifications may be illegal under Federal law. The modification ban also applies to Midway Games Incorporated and game logos, designs, publications and assemblies. Moreover, facsimiles of Midway equipment (or any feature thereof) may be illegal under federal law, regardless of whether or not such facsimiles are manufactured with Midway components.

WARNING. Prevent shock hazard and assure proper game operation. Plug this game into a properly grounded outlet. Do not use a cheater plug to defeat the power cord's grounding pin. Do not cut off the ground pin.

CAUTION. A very small portion of the population has a condition which may cause epileptic seizures or momentary loss of consciousness when viewing certain kinds of flashing lights or patterns that are present in our daily environment. These persons may experience seizures while watching some kinds of television pictures or playing certain video games. People who have not had any previous seizures may nonetheless have an undetected epileptic condition.

If you or anyone in your family has experienced symptoms linked to an epileptic condition (e.g. seizures or loss of awareness), immediately consult your physician before using any video games.

We recommend that parents observe their children while they play video games. If you or your child experience the following symptoms: dizziness, altered vision, eye or muscle twitching, involuntary movements, loss of awareness, disorientation, or convulsions, DISCONTINUE USE IMMEDIATELY and consult your physician.

CAUTION. Information in this manual is subject to change without notice. Midway reserves the right to make improvements in equipment function, design, or components as progress in engineering or manufacturing methods warrants.

COPYRIGHT & TRADEMARK NOTICE. You may not reproduce any part of this publication by mechanical, photographic, or electronic means. You may not produce phonograph recordings of this document. You may not transmit this publication or otherwise copy it for public or private use, without permission from the publisher.

For Service: Call your Authorized Midway Games West Inc. Distributor.

©1998, 1999 Midway Games West Inc. All rights reserved. MIDWAY® is a trademark of Midway Amusement Games, LLC. Used by permission. GAUNTLET® DARK LEGACY™ is a trademark of Midway Games West Inc.

midway games west inc.
675 sycamore drive
milpitas, california 95035
<http://www.midway.com>



MARCH 2000
16-34046-101

Conversion
Kit

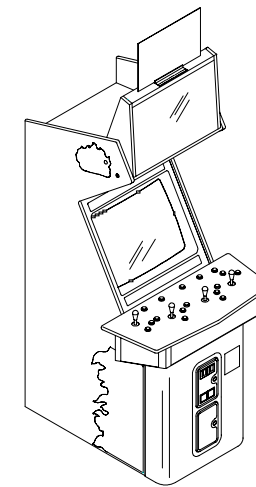

UNIVERSAL CONVERSION KIT

Operations Manual Includes

Setup • Service • System • Wiring • Troubleshooting

The manufacturer intends that this game is to be operated for amusement purposes only and not in contravention of any federal, state or local law or regulation of the United States or any foreign country governing gaming devices. All operators of this game are responsible for its operation in accordance with such laws and regulations. The manufacturer's factory settings for this game may require adjustment in order to comply with laws applicable in an operator's specific jurisdiction. It is the operator's responsibility to determine whether adjustments are necessary and, if they are, to make the appropriate adjustments prior to operating the amusement game.

midway games west inc.
675 sycamore drive, milpitas, california, 95035
<http://www.midway.com>

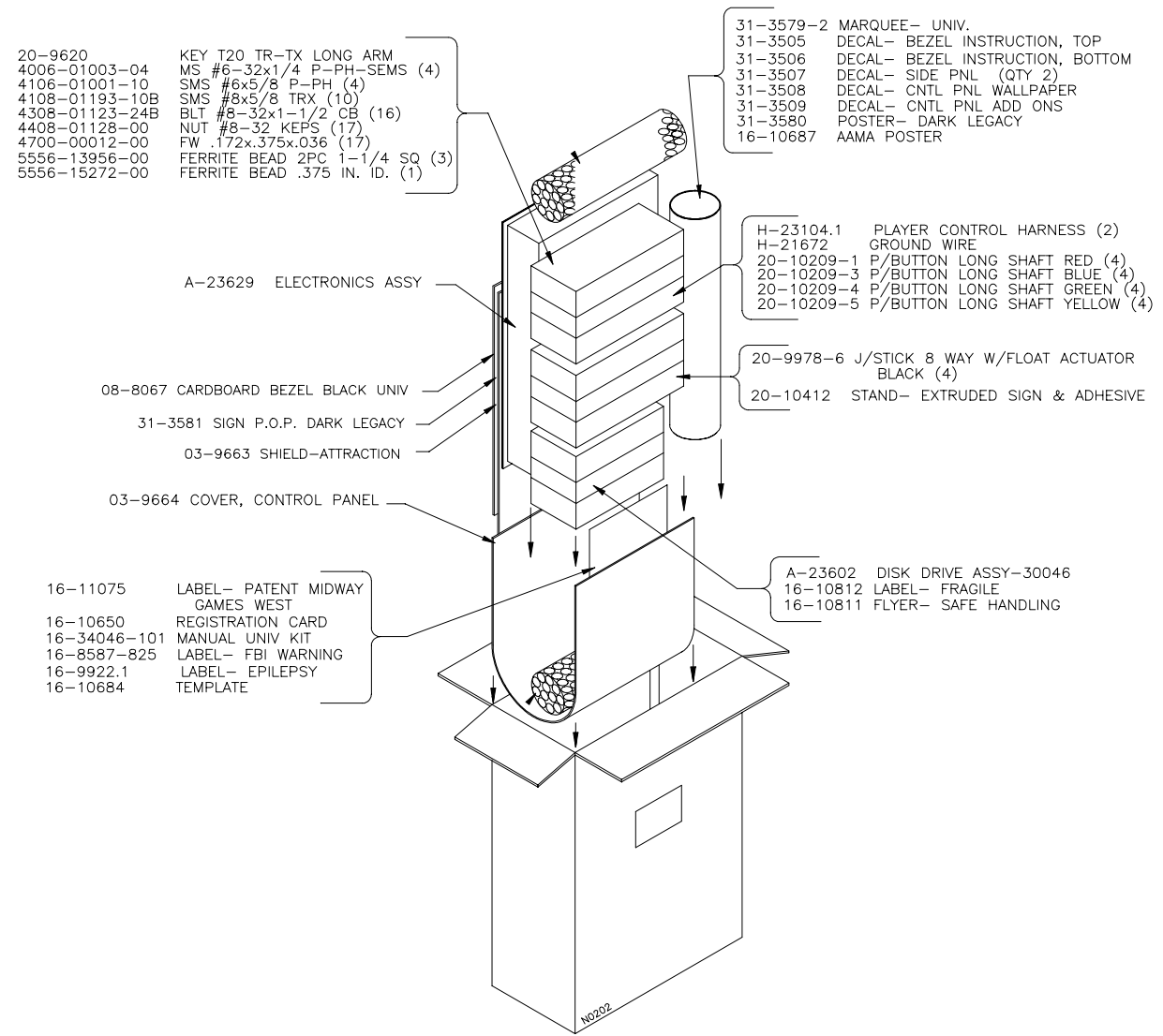

CONTENTS OF UNIVERSAL KIT PACKAGING

GAUNTLET DARK LEGACY

CHAPTER

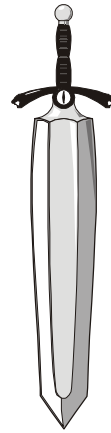

Setup









NOTICE: Information in this manual may change without notice. Midway Games West Inc. reserves the right to make improvements in equipment function, design, or components as progress in engineering or manufacturing methods may warrant.

SAFETY INSTRUCTIONS

The following safety instructions apply to operators and service personnel. Read these instructions before preparing the game for play. Other safety instructions appear throughout this manual.

DEFINITIONS OF SAFETY TERMS

- **DANGER** indicates an imminent hazard. If you fail to avoid this hazard, it **WILL** cause death or serious injury.
- **WARNING** indicates a potential hazard. If you fail to avoid this hazard, it **COULD** cause death or serious injury.
- **CAUTION** indicates a potential hazard. If you fail to avoid this hazard, it **MAY** cause minor or moderate injury. **CAUTION** also alerts you about unsafe practices.
- **NOTICE** indicates information of special importance.

	<p>CAUTION. HANDLE DRIVES CAREFULLY The hard disk drive must be packed in an anti-static bag. When shipping the drive for repair or replacement, pack it in an approved container (P/N 08-8068). Do not stack or drop hard disk drives.</p>
	<p>WARNING. DISCONNECT POWER Always turn AC power off and unplug the game before attempting service or adjustments unless otherwise instructed. Installing or repairing PC boards with power ON can damage components and void the warranty.</p>
	<p>WARNING. GROUND GAMES. Avoid electrical shocks! Do not plug in a game until you have inspected and properly grounded it. Only plug this game into a grounded, three-wire outlet. Do not use a "cheater" plug, or cut off the ground pin on the line cord</p>
	<p>CAUTION. ATTACH CONNECTORS PROPERLY. Ensure proper mating. Do not force connectors that do not slip on easily. Reversed connectors may damage game and void warranty. Connector keys allow a connector to fit only one set of pins on a board.</p>
	<p>WARNING. HAZARD TO EPILEPTICS. A very small portion of the population has a condition that may cause them to experience epileptic seizures or have momentary loss of consciousness when viewing certain kinds of flashing lights or patterns present in our daily environment. These persons may experience seizures while watching some kinds of television pictures or playing certain video games. People who have not had any previous seizures may nonetheless have an undetected epileptic condition.</p> <p>If you or a family member experiences symptoms linked to an epileptic condition (e.g., seizures or loss of awareness), consult a physician at once before playing video games.</p> <p>We recommend that parents observe their children while they play video games. If you or your child experience the following symptoms: dizziness, altered vision, eye or muscle twitching, involuntary movements, loss of awareness, disorientation, or convulsions, DISCONTINUE USE IMMEDIATELY and consult a physician.</p>
	<p>NOTICE. FCC COMPLIANCE. Installation of this kit into any existing product does not guarantee compliance with FCC requirements. You are solely responsible for FCC compliance for installations in other products. Any existing FCC compliance sticker must be removed and a new sticker should not be installed on the converted product until you have verified FCC compliance.</p>

Special Note for optional1, 2 or 3-player conversion

If you choose not to install all included joysticks and buttons, you must change the Game Options setting in the Menu System to a one-, two-, or three-player cabinet type.

Product specifications

Equipment Requirements		
<i>Video Display</i> Medium Resolution RGB or Standard Resolution RGB (adjustable at U12 DIP switches)	<i>Audio System</i> 2 Channel Audio	<i>Wiring</i> JAMMA Harness
Game Characteristics		
<i>Player Variables</i> 1 to 4 Players Per Game Choice of Character Character Profile Memory	<i>Operator Variables</i> Coinage, Game Options, Dif- ficulty, Volume, Demo Mode, Audits, Statistics	<i>Diagnostics</i> Automatic Power-Up Test Manual Multi-Level Menu System

Kit Components

	NOTICE. Gauntlet: Dark Legacy Universal Conversion Kit conversion requires use of medium resolution monitor. You must also have a standard JAMMA wiring harness; a harness is not included in this kit. Check Wiring Diagram during installation to ensure correct JAMMA harness mating.
---	---

Unpack materials from carton and inspect for obvious signs of damage. Use this checklist to ensure the kit is complete. Some of these parts may already be installed. You must supply the remainder of the materials required for this conversion.

Part No.	Item	Qty.	Part No.	Item	Qty.
Electronics			Marquee		
A-23602	Hard Disk Drive	1	03-9663	Marquee Shield	1
A-23629	Electronics Assy	1	31-3579-2	Marquee Artwork	1
H-21672	Ground Wire	1	31-3581	POP poster	1
H-23104.1	Control Harness	2	20-10412	Plastic POP holder	1
5556-13956-00	2-piece ferrite clamp 1/2-inch ID	3	Bezel		
5556-15272-00	ferrite clamp 1/4-inch ID	1	31-3505	Top Instructions	1
Control Panel			31-3506	Bottom Instructions	1
03-9664	Plastic Panel Cover	1	08-8067	Cardboard Bezel	1
16-10684	Panel Template	1	16-9922.1	Epilepsy Warning	1
20-10209-1	Red button	4	Hardware and Tools		
20-10209-3	Blue button	4	4006-01003-04	screw 6-32 x 1/4	4
31-3507	Side Panel Decal	2	4106-01001-10	screw #6 x 5/8	4
20-10209-4	Green button	4	4108-01193-10B	screw #8 x 5/8 torx	10
20-10209-5	Yellow Button	4	4308-01123-24B	bolt 8-32 x 1 1/2	16
31-3509	Button Name Decals	1	4408-01128-00	8-32 keps nut	17
31-3508	Wallpaper decal	1	4700-00012-00	washer	17
20-9978-6	8-way joystick	4	20-9620	Torx wrench	1

Recommended tools and supplies

Utility knife, screwdrivers, liquid soap, nut drivers or socket wrench, wood filler material, black electrical tape, hole saw or equivalent, squeegee, soldering iron and solder, pliers or wire cutters, 180 grit sandpaper or electric sander, black semi-gloss paint, electric drill and wood drill bit set.

CONVERTING A TYPICAL VIDEO GAME CABINET

PREPARE EXISTING CABINET

1. Verify operation of existing game before modifying cabinet. Pay special attention to parts you will reuse during conversion (e.g., power supply, monitor, coin mechs). Repair or replace damaged parts before installing kit.
2. Switch off AC power. Disconnect AC line cord. Clear work area and cover or protect non-wood items (marquee, monitor, coin door, brackets, line cord, etc.).
3. **ARTWORK** Note location of decals or artwork and remove. Clean off glue residue. Fill gouges or unused holes with suitable filler material like quick-hardening wood putty. Sand wood smooth and remove dust.
4. Evenly cover entire cabinet with black paint and allow to dry before continuing.
5. **SIDE DECALS** Sponge soapy water over position of previous decal where you wish to locate decal on left side. See illustration below for location suggestion.
6. Remove an inch or two of Dark Legacy side decal backing paper to reveal some adhesive edge.
7. Line up exposed edge of decal and set down on cabinet.
8. Carefully remove a little more backing paper and place new decal onto of cabinet. Make location adjustments before removing backing paper from flames, as flames are more likely to tear than words.
9. Use dry sponge to flatten decal out as you place it down. Flatten out any air bubbles. Pop any persistent air bubbles with a knife or pin. If necessary, trim decal to fit cabinet.
10. Repeat previous five steps for right side decal.
11. **MARQUEE** Remove existing marquee from cabinet. Check lamp and replace if cracked or if ends are darkened, even if it still works. Trim kit marquee to fit and install. Using previous shield as a guide, trim new attraction shield to size and deburr edges. Install new marquee attraction shield.
12. **BEZEL** Remove viewing glass and set in safe place. Clean CRT glass. Install black cardboard bezel in front of monitor. Apply instructions decals to top and bottom of bezel. Place Epilepsy Warning label on front of monitor bezel. Ensure decals and labels do not obstruct viewing area. Clean bezel and viewing glass before installing in cabinet.
13. **CABINET** Unlock and remove rear door. Use vacuum cleaner to remove dirt or debris inside cabinet.

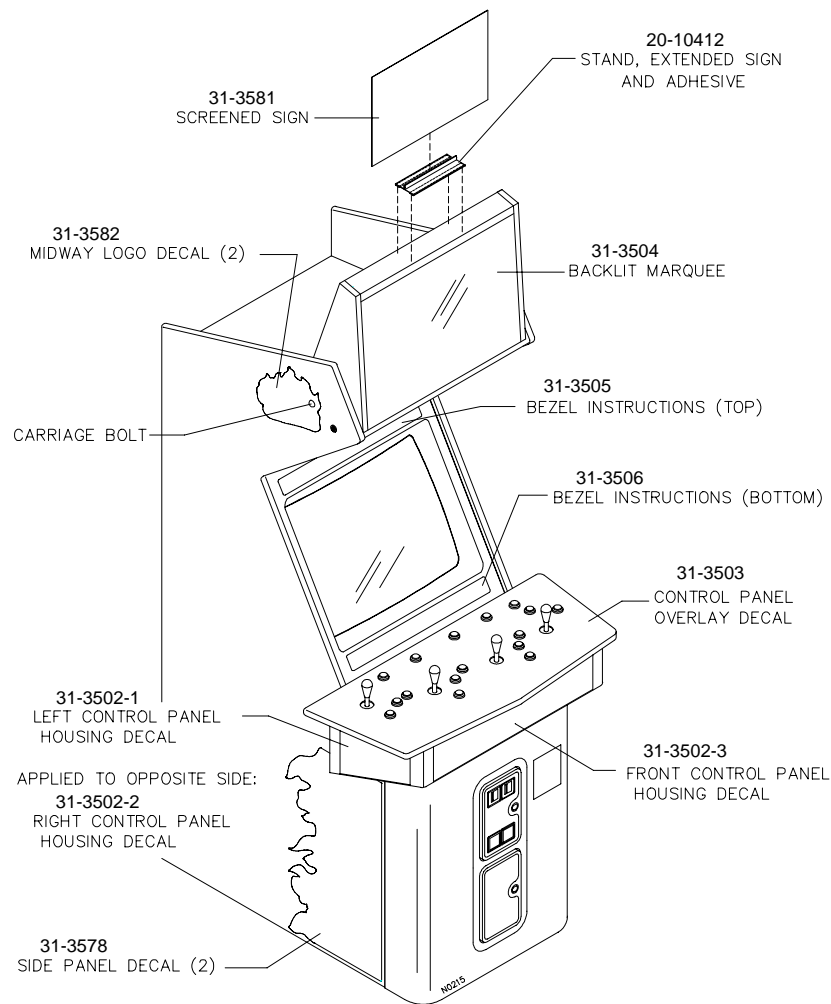

DECAL LOCATION

14. **CONTROL PANEL** Locate and unlock control panel latches or fasteners. Free panel from operating position. Label harness wires before disconnecting from controls. Once wires are disconnected, remove control panel and set aside. Save mounting brackets and hardware for later reinstallation.
15. Some control panels have speakers or other components. Note wire polarity and function before disconnecting. Incorrectly phased speakers cause weak low frequencies or a thin, hollow sound quality.

INSTALL PLAYER CONTROLS

1. **TEMPLATE** If control panel template is creased, flatten with books, newspapers, magazines, etc.
2. Remove buttons, joysticks, or other controls from control panel. Remove covering and artwork, hinges or mounting brackets.
3. Fill holes with suitable material (i.e., wood putty, glue, etc.). Let dry. Sand or file flat both sides of surface. Should you choose to replace the control panel board, it must match the original panel in size and thickness, and include all fastening and grounding hardware.
4. Tape template on panel. Orient template to center controls. Cut and deburr holes. Remove template.

5. **DECAL** Remove backing and apply control panel decal to panel. Work down from top. After decal is in place, smooth it outwards, squeezing out air bubbles. Pop persistent air bubbles and smooth decal.

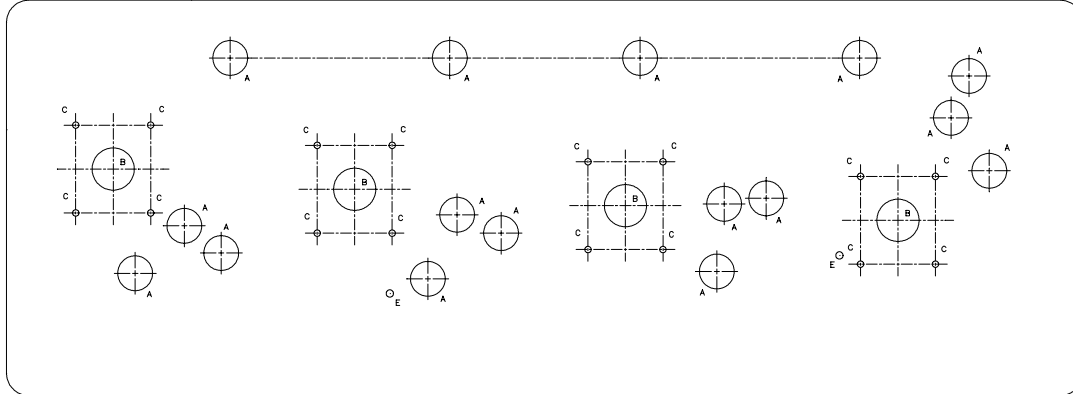

CONTROL PANEL TEMPLATE

6. Let adhesive set. Trim decal edges and cut joystick, button, and keypad holes to fit control panel.
7. **BUTTON DECALS** Position control decals next to appropriate holes according to illustration.
8. **OVERLAY** Place plastic overlay on top of panel decals. Deburr overlay edges. Tape control panel template on top of overlay in same position as holes beneath overlay. Cut and deburr holes. Remove template. Fasten overlay with included hardware.
9. **BUTTONS** Disassemble each switch from its pushbutton. Bend large prong away from switch enough to slide switch off housing. Unscrew nut from housing.
10. Insert pushbutton housing through a button hole from top of control panel. Screw nut finger tight on switch housing from underside of panel. Snap switch back on housing. Repeat for each button.
11. Rotate pushbuttons so switch terminals are oriented toward JAMMA harness. Tighten nuts firmly.
12. **JOYSTICKS** Insert joystick through hole from bottom of control panel. Align mounting holes in joystick base with control panel holes and insert carriage bolts from top of control panel. Install nuts from bottom of control panel over bolts and tighten securely. Repeat for each joystick.



INSTALL ELECTRONICS





WARNING. DISCONNECT POWER. To avoid electrical shock, turn off power switch and disconnect AC line cord before removing or replacing any component. After servicing components, be sure all ground wires are secure before restoring power.

1. **REMOVE OLD ELECTRONICS** Label, then carefully disconnect cables on each printed electronics board assembly in cabinet. Note orientation of JAMMA edge connector on CPU Board Assembly. Remove boards and store in anti-static bags. Leave JAMMA harness in cabinet so you can reuse it.
2. **PREPARE ELECTRONICS** Place Gauntlet: Dark Legacy Universal Conversion Kit electronics assembly on flat, static-free work surface. Remove electronics cover and set aside. Inspect electronics for any damage and ensure all connectors are properly seated.
3. **LOCATE ELECTRONICS** Place new groundplane (with electronics assembly, but without hard drive or groundplane cover) in location of previous assembly. JAMMA edge connector header should face same direction as previous connector header. Mark mounting holes and set electronics aside.
4. **MOUNT ELECTRONICS** Drill pilot holes where necessary and use hex-head screws to attach electronics to cabinet wall. Set DIP switches as needed (See Wiring Chapter).

WIRE CABINET

	NOTICE. You must install a JAMMA wiring harness, or modify a JAMMA harness from an existing game. Inspect existing cabinet wiring and compare with Cabinet Wiring Diagram in Chapter 4. Most games already have compatible wiring, but if your connectors do not mate well with the Sound I/O Assembly, or if wire colors do not match the chart, contact your authorized distributor for assistance.
	CAUTION: ATTACH CONNECTORS PROPERLY. Be sure that printed circuit board (PCB) connectors mate properly. If connectors do not slip on easily, do not force them. A reversed connector may damage video game machine and void warranty. Connector keys only allow a connector to fit one set of pins on a board.
	WARNING: OBSERVE GROUNDING. Be aware of ground wires in game. Ground wires are usually green or green with a yellow stripe. Reuse any existing ground wires, and use ground wires included in this kit.

1. **JAMMA HARNESS** When wiring JAMMA harness to the controls and the CPU Board Assembly, refer to Cabinet Wiring Diagram in Wiring Chapter.
2. Attach component end of JAMMA harness to mate on Sound I/O Assembly.

	NOTICE. Some older JAMMA connectors may require modification to work properly. Carefully observe Wiring Diagram, especially +12, +5, and -5 connections. Improper power supply connections can damage your video game machine.
	CAUTION. Properly insulate any unused wires within the JAMMA wiring harness, especially red, yellow, orange, and black power wires. Secure any unused connectors away from game electronics.

3. Attach Player 3 connector of control harness H-23104.1 to mate on Sound I/O Assembly at P14. (Does not apply to 2-player games.)
4. Attach Player 4 connector of second control harness H-23104.1 to mate on Sound I/O Assembly at P7. (Does not apply to 2-player games.)
5. Attach coin door connector to mate on Sound I/O Assembly at P23.
6. Ensure that Hard Drive power cable is snug in its mate on Sound I/O Assembly at P3.
7. Ensure that Hard Drive data cable is snug in its mate on CPU Board Assembly at P4.
8. Double check your connections to ensure they are all firm and secure. Do not force connectors, as they are keyed to fit only one way. Secure wiring to cabinet using your own cable clamps and screws. Maintain original cable routing where possible.
9. If necessary, reconnect speakers to JAMMA harness as indicated in Wiring Diagram.
10. Reconnect any ground wires loosened or removed in previous steps.
11. **BUTTONS P1 and P2** Observe Wiring Diagram and connect JAMMA harness to all Player 1 and Player 2 buttons. Modify harness as necessary. Take special precautions to ensure each button is connected to ground through JAMMA harness black ground.
12. **BUTTONS P3 and P4** Connect appropriate control harness to Player 3 buttons, according to Wiring Diagram. Repeat with remaining harness for Player 4 buttons.
13. **JOYSTICKS P1 and P2** Observe Wiring Diagram and connect JAMMA harness to Player 1 and Player 2 joysticks. Modify harness as necessary. Take special precautions to ensure each button is connected to ground through JAMMA harness black ground.
14. **JOYSTICKS P3 and P4** Connect remaining wires to Player 3 and Player 4 joysticks

15. Close and lock control panel using existing fasteners..

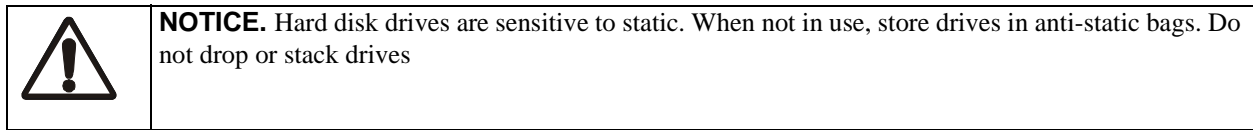

16. **HARD DISK DRIVE** Mount hard drive onto hard disk drive bracket and fasten using #6-32 screws, lockwashers, and flat washers in each hole.

17. Mount bracket onto studs on electronics assembly and fasten with KEPS nuts. Orient bracket with connectors near CPU Board Assembly.

18. Connect data ribbon cable and power cable to Hard Disk Drive.

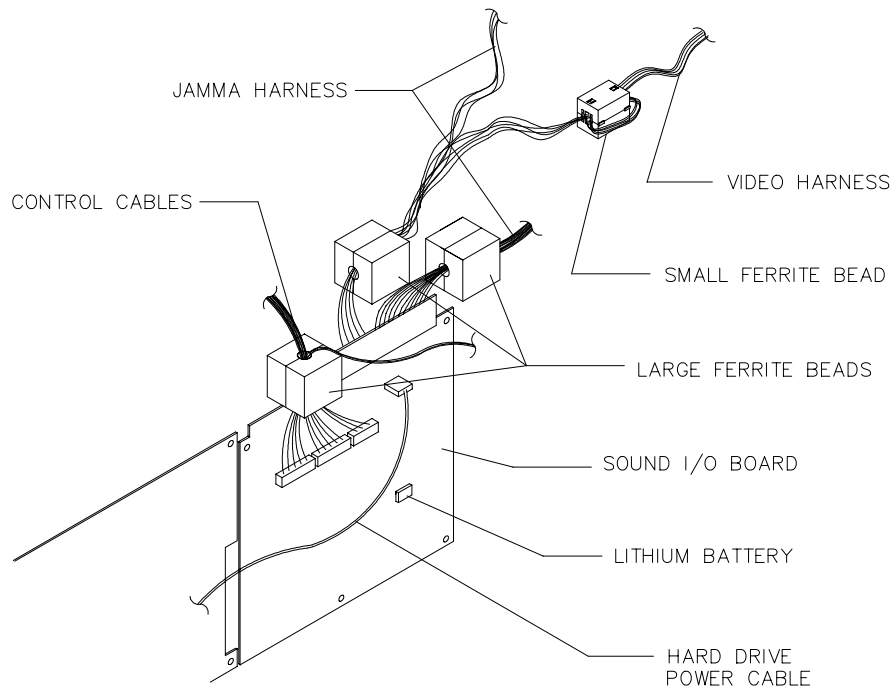

19. **FERRITE BEADS** Locate the square, split ferrite beads. Separate harness wires into three bundles where they attach to JAMMA connector. Install one large ferrite bead around DC power conductors (solid color heavy gauge wires with pin numbers 1-6 and A-F). Install another large bead around remaining wires. Install third large bead around control panel conductors (striped color lighter gauge wires). Place small ferrite bead on video wires of JAMMA harness, wrapping wires around one side of this bead. Refer to illustration for bead locations. Place beads as close to JAMMA connector as possible. Ensure no wires are pinched, then close and lock each bead.

20. Ensure all wires, ferrite beads, etc. are secure inside electronics enclosure. Replace groundplane cover, routing wires through cutout in cover and ensuring no wires are pinched. Secure to groundplane using all but one of the enclosed nuts.

21. Attach one end of second ground braid (H-21672) to remaining groundplane post and fasten nut. Secure other end of braid to safety ground on power supply

22. Replace and lock rear door.

POWER UP AND TEST GAME

1. Plug line cord into AC power source and turn on power switch. LEDs in electronics cage should illuminate. Use 20-volt DC setting on a digital voltmeter to measure DC voltages at power connector pins. Adjust +5V source if is necessary. Voltage tolerances are ± 4 on +5V, $\pm 1/2$ V on +12V.
2. The game begins self diagnostics. If no errors are found, Attract Mode begins. If problems occur, check wiring and refer to Troubleshooting Chapter.
3. Unlock and open coin door. Press and hold TEST button to access Menu System. Use tests to verify operation of monitor, hard drive, speakers, and all pushbuttons and joysticks.
4. Exit the Menu System to begin normal game operation. Open the coin door and press the SERVICE CREDITS button to allow game play. Choose a player position and press the START button to begin. Listen to the audio while playing the game. Note unexpected irregularities in sound (out of phase, no low frequencies, etc.). Check the wiring harness for internal shorts. Refer to Wiring for jumper locations and recommended settings, or Troubleshooting.
5. Close and lock coin door.
6. Play several games to test operation of player panel buttons. Do they function? Do they operate consistently? Does each control perform its designated operation? Game play and earnings depend on proper performance of the VIEW, START and movement buttons. If any button does not operate properly, check connections against the wiring diagram. Replace intermittent or otherwise faulty controls.



CAUTION: SEEK FCC APPROVAL. Installation of this kit does not guarantee compliance with FCC requirements. You are solely responsible, and Midway has no responsibility for FCC compliance of installed kits. Don't install an FCC compliance label on the product until the FCC acknowledges compliance.

GAUNTLET DARK LEGACY

CHAPTER

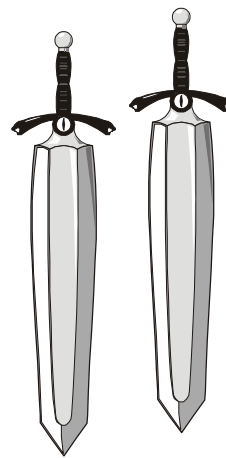

Service



NOTICE: Information in this manual may change without notice. Midway Games West Inc. reserves the right to make improvements in equipment function, design, or components as progress in engineering or manufacturing methods may warrant.

Only qualified service personnel should perform maintenance and repairs. Product guidelines apply to all game operators and service personnel. Specific notes, cautions, and warnings abound throughout this manual where applicable. Read the safety pages before beginning service.

This video game machine uses complex electronic components that are very sensitive to static electricity. Observe and follow these precautions prior to handling the game electronics:

- Ensure AC power is turned off prior to servicing electronics.
- Discharge any static electricity build up in your body by first touching the metal power supply chassis. Do this *before* touching or handling the electronic assemblies.
- Store electronic assemblies in an anti-static area. Use anti-static bags to store or transport hard disk drive, CPU Board Assembly, and all other electronics.
- *Do not* remove or connect electronics with AC power on, as this will damage them and void the warranty.
- Always replace ground wires, shields, covers, etc., when maintenance or service is completed.

	CAUTION. Discharge any static electricity buildup in your body by touching the power supply chassis before touching or handling electronics assemblies.
---	--

CPU Board Assembly

Switch off AC power. Open rear door. Remove metal electronics cover. Carefully note orientation of JAMMA connector and other cables. Extract harnesses and hard disk drive ribbon cable from board connectors. Remove groundplane mounting screws and security lock. Slide entire electronics assembly toward rear of cabinet and lift to remove it. Set electronics assembly in a static-free place. Disconnect VGA connector. Remove security mounting bolts and screws connecting circuit boards to groundplane. Carefully remove Sound I/O Board, pulling gently to disconnect PCI edge connector from CPU Board. Set Sound I/O board in a static-free place. Carefully remove CPU Board, pulling gently to disconnect it from Video Card. Use anti-static bags and protective containers from new parts to store board if it is not reinstalled.

Hard Disk Drive

	CAUTION. Hard disk drives are fragile. Never move a game with AC power on. Never stack or drop hard disk drives.
---	---

Switch off AC power. Unlock and remove cabinet door. Remove electronics cover. Disconnect DC power cable from hard disk drive. Unplug ribbon cable from hard drive and leave it attached to CPU board. Care-

fully remove screws and lift drive assembly out of cabinet. Store drives in anti-static bags or approved shipping containers.

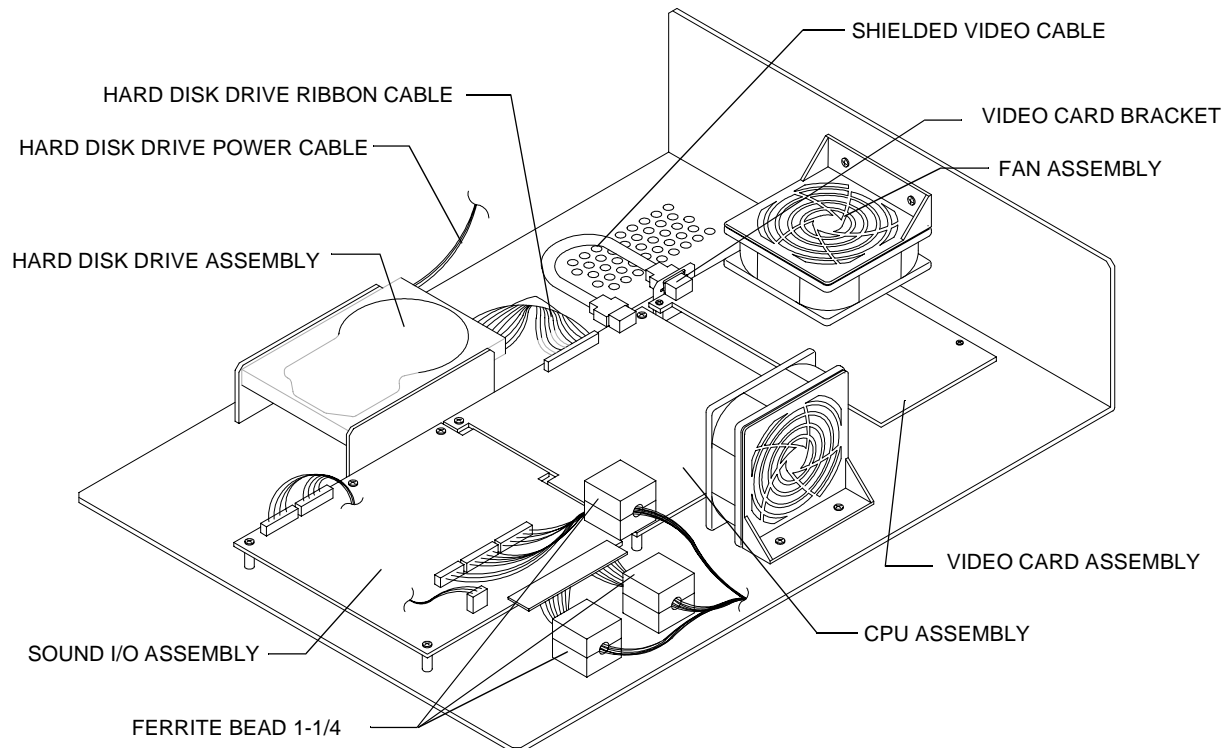

ELECTRONICS ASSEMBLY

Sound I/O Assembly

Switch off AC power. Open rear door. Remove electronics cover. Carefully note orientation of JAMMA connector and other cables. Extract harnesses and hard disk drive ribbon cable from board connectors. Remove groundplane mounting screws and security lock. Slide entire electronics assembly toward rear of cabinet and lift to remove it. Set assembly in static-free place. Remove security mounting bolts and screws connecting circuit board to groundplane. Carefully remove Sound I/O Board, pulling gently to disconnect PCI edge connector from CPU Board. Use anti-static bags and protective containers from new parts to store board if it is not reinstalled.

Video Card

Switch off AC power. Remove rear door. Remove Electronics Assembly cover. Disconnect VGA connector. Remove screws holding the Video Card to groundplane. Carefully slide Video Card away from CPU Board, disconnecting PCI edge connector. Use anti-static bags and protective containers from new parts to store the board if it is not reinstalled.

Battery

Switch off AC power. Remove rear door. Remove Electronics Assembly cover. Hold battery edges and pull up firmly to remove. When installing new battery, note position of keyhole in socket. Replace only

with same or equivalent type recommended by manufacturer. Dispose of used batteries according to instructions on battery package.

Memory

The ROM (Read Only Memory) circuits contain game operating instructions. Switch off AC power. Carefully note position, then remove using a chip extraction tool.

To reinstall, orient chip over its socket and press firmly to seat pins. Do not force.

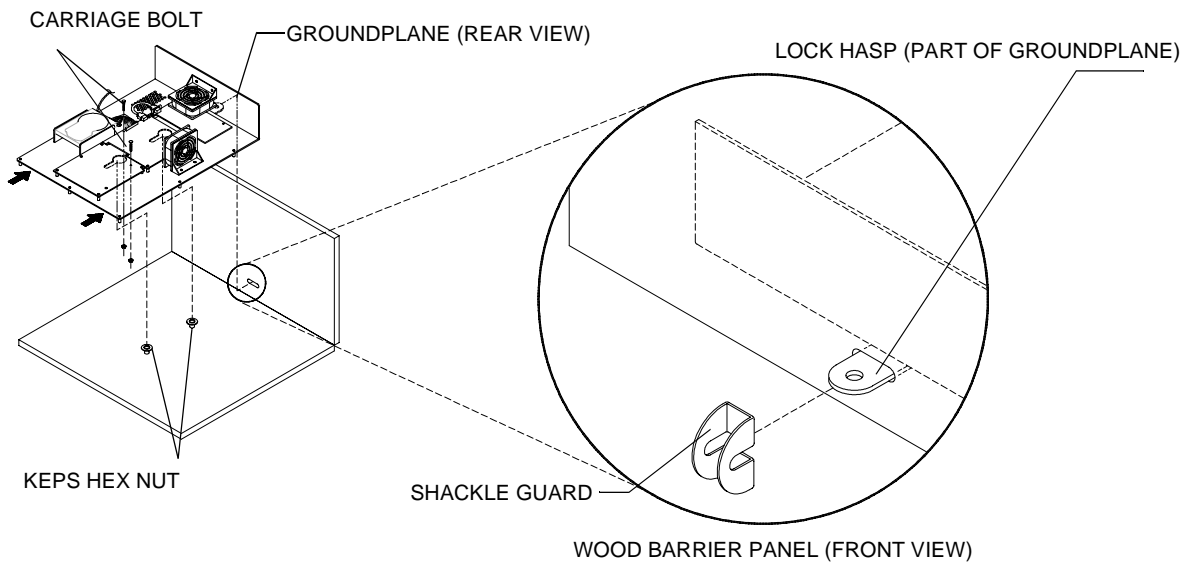

Game Electronics Security

The shackle guard shipped with cabinet is intended for use on rear door. An additional guard may be used to safeguard game electronics.

Memory Replacement

The ROM (Read Only Memory) circuits contain game operating instructions. Memory devices are especially sensitive to static charges. Use grounding precautions when handling these parts.

Switch off AC power. Unlock and remove rear door. Remove electronics cover. Carefully note each IC position, then remove them using a chip extraction tool. To reinstall memory circuits, orient chip over socket and press firmly to seat pins. Do not force.

GAUNTLET DARK LEGACY

CHAPTER

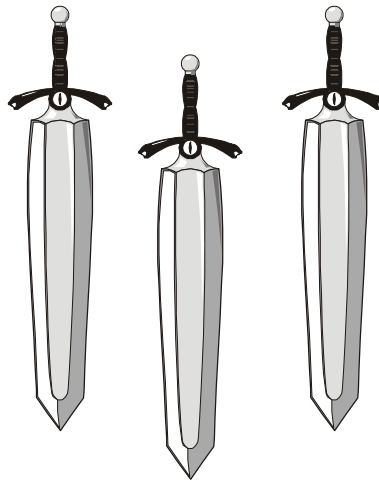

System



NOTICE: Information in this manual may change without notice. Midway Games West Inc. reserves the right to make improvements in equipment function, design, or components as progress in engineering or manufacturing methods may warrant.

STARTING UP

Each time the game is first turned on or power is restored, it begins executing code out of the boot ROM. These self-diagnostic tests automatically verify and report condition of the hardware and the disk drive. The screen is blank during these tests. If any of the individual tests fails, then an error message will be displayed for each test. The message will be displayed for 30 seconds or until any button is pressed.

- If no buttons are pressed, the system will quickly complete all tests then load and run the game.
- Press and hold the TEST button inside the coin door to skip the boot ROM tests and activate the Self-Test Menu System.

Once all Power-up tests have been passed, the game goes into Attract Mode. Scenes and sounds from a typical game are alternated with previous high scores in an endless pattern until game play starts.

Insert currency to start game. Play begins after a mission is chosen. The game progresses until time runs out. If no more play is required, the game automatically returns to the "attract mode".

GAME RULES

Play instructions are on information panel between speakers. Up to four players at a time can explore a world, facing hordes of monsters, searching for treasure, avoiding traps, finding and using magic, and adventuring their way to the exits.

Players choose from eight characters (and, later, eight alternate characters) to face the hordes of monsters that have overrun the land of Gauntlet. With more than 100 unique monsters and 10 intimidating boss characters, players have their hands full, defeating each of the eight world bosses and collecting keys before meeting the demon Skorne. Following Skorne's defeat, players must defeat him yet again in an underworld level, after which they face the evil overlord Garm. Numerous power-up enhancements are scattered throughout the land to help players get to the finish.

Players can save their character with player IDs. One password saves all eight different characters. During game variable selection, players simply enter their initials and their own 3-letter player ID that they choose. The characters, with their experience levels and current ratings for strength, speed, toughness, and magic are automatically saved along with any Rune Stones players find.

To access the alternate characters, players first build characters to level 10. Depending upon which character they have played, they then can choose to play as the Minotaur (Warrior), Falconess (Valkyrie), Jackal (Wizard), Tigress (Archer), Hyena (Jester), Ogre (Dwarf), Medussa (Sorceress), and Unicorn (Knight).

To defeat Garm, players must find all 13 Rune Stones and defeat Skorne twice. Three Stones are hidden in each world. Upon finding a Stone, a character is saved permanently with a password.

There are over 35 unique special weapons found throughout the game that will help players in their quest. These power-ups are found in chests and barrels, in nooks and crannies, and even in plain view and can be bought with gold in the Shop.

INDIVIDUAL AND MULTIPLE PLAY

Insert currency to start game. Select a joystick/button combination and press START. Select a password, character, and journey. In multi-player games the first to select a journey determines everyone's path. On-screen life counters decrease as characters are wounded until they reach zero, at which point the player must deposit more coins to continue. You can continue playing after others drop out. When coins are inserted, the character joins in the middle of the action.

PLAYER CONTROLS

START buttons let players begin or continue play and also select items from the service menu.

FIGHT/MAGIC/TURBO Buttons attach enemies. Players access special turbo movies by pressing TURBO and FIGHT at the same time when their "fight bar" has been charged up.

Magic is used by pressing TURBO + MAGIC and FIGHT + MAGIC during game play.

Between levels, players redeem accumulated gold for valuable power-ups and things that will enhance their characters like strength, toughness, speed, and magic.

JOYSTICKS advance a character along a journey and select items from service menu.

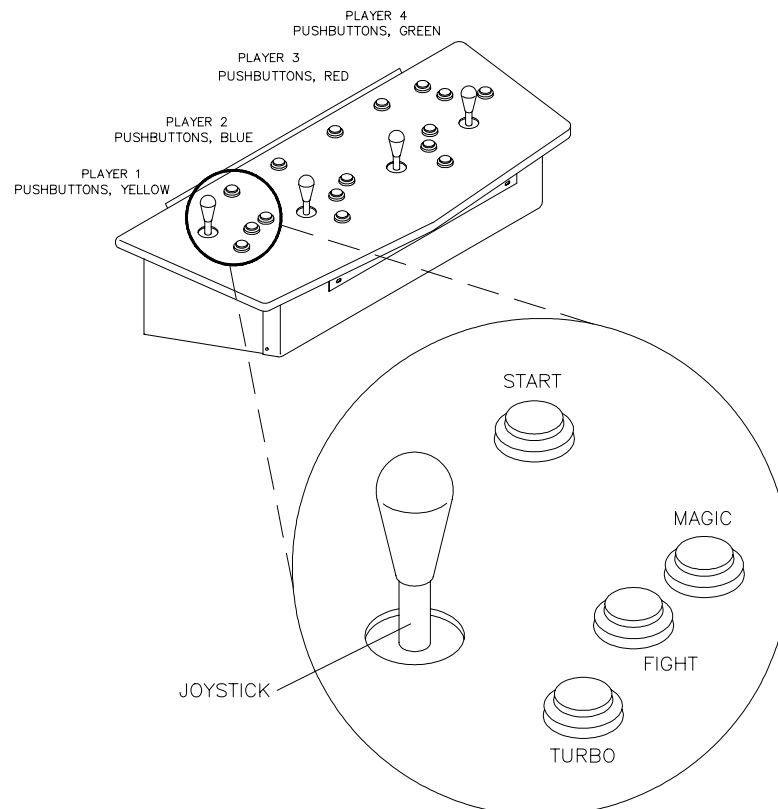

PLAYER CONTROL LOCATIONS

OPERATOR CONTROLS

Operators have lock-and-key access to the menu system for statistics, adjustments, and testing to prevent tampering. On-screen messages guide the operator through menu options.

Control Switches

Volume Down and Volume Up Buttons (typically mounted on a bracket behind the coin door, or on the coin door itself) increase or decrease game sound levels.

NOTE Attract Mode volume is set as a percentage of Game Mode volume. When volume up/down buttons are pressed during Attract mode the volume is temporary set to game volume.

For greater profits, adjust volume levels to a loud setting to draw attention to this game.

Test Mode Button The Test Mode push-button switch enters the menu system. Press the Test Mode button briefly to run automatic tests. To make changes, press and hold Test until the system menu is displayed.

Service Credit Button: this button allots credits without changing the game's bookkeeping total.

These buttons may also be used instead of the control panel buttons and joystick when operating the menu system.

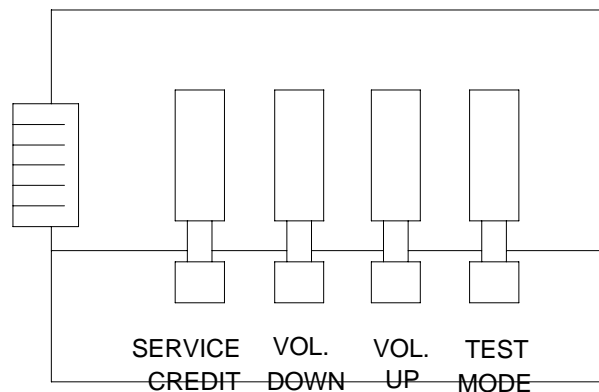

TYPICAL ORIENTATION OF TEST SWITCHES

MENU SYSTEM

SYSTEM OVERVIEW

Game variables and diagnostics are presented in a series of on-screen menus. The Main Menu allows you to view information, change or verify equipment operation. Submenus display further choices, after which more data appears or tests run. Use both operator and player controls to navigate menus and start or stop routines.

SCREEN LAYOUT

The color bar at the top center of each screen displays the current menu title. The center of the screen holds data (menu items, video signals, statistics, reports, etc.) The bottom of the screen contains messages (control functions, revision levels, etc.).

ORGANIZATION

Main Menu screen items are either options or tests. Submenu screen items offer choices within a category. A Menu may have zero, one, or several Submenus. You can always return to the previous menu, and often advance to the next menu. Detail Menu screen items contain specific information. You interact with the system to get results or to make changes.

Use the indicated control to highlight an item. You can only select one highlighted at a time. To return to game play, select EXIT TO GAME, then press the indicated button.

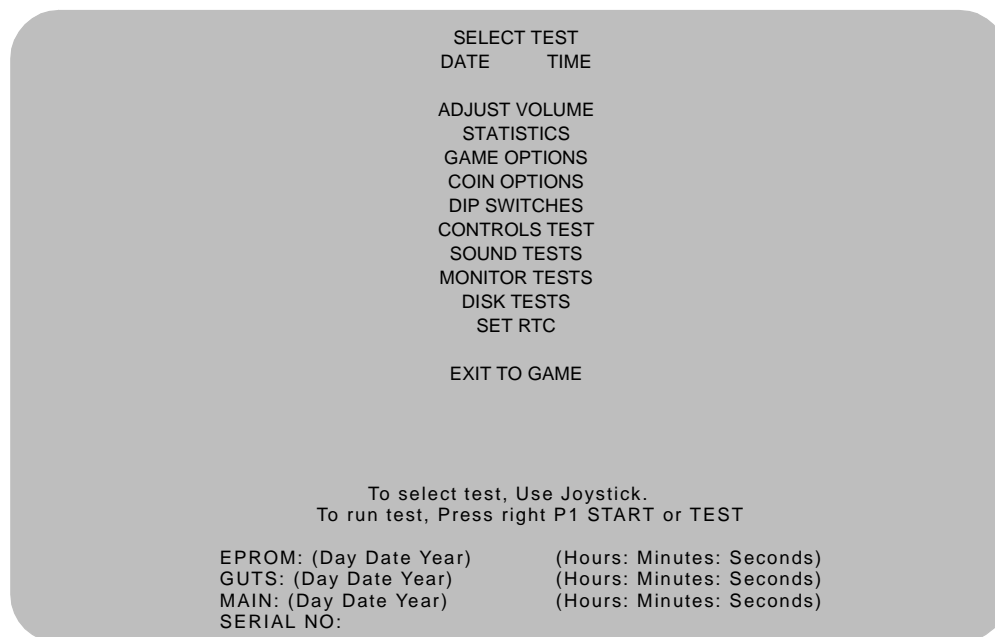

TYPICAL SELECT TEST MENU SCREEN

ADJUST VOLUME

You can adjust Attract Mode volume independently of Game volume. Use the joystick to raise or lower volume level. Music plays continuously while setting volume.

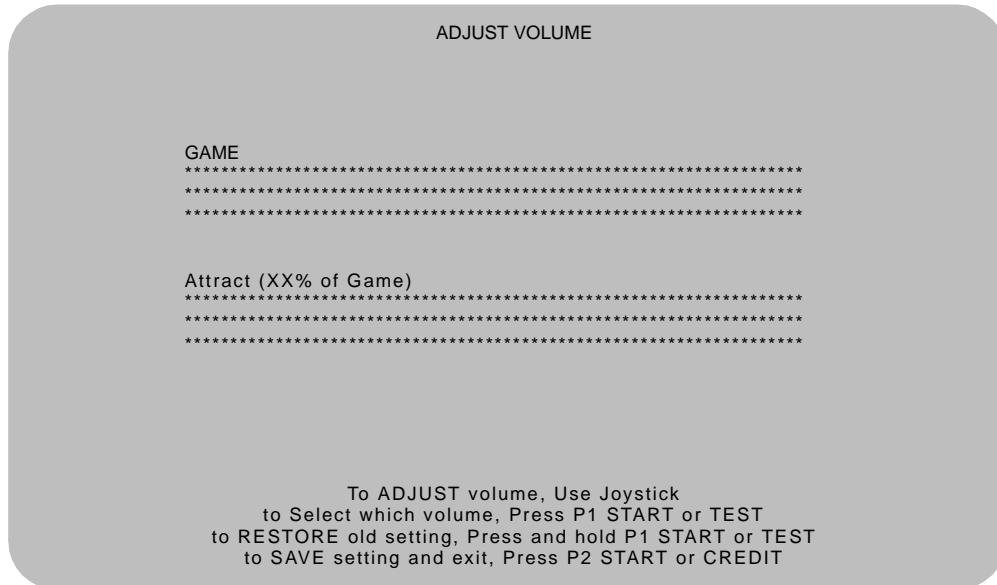

VOLUME ADJUSTMENT MENU SCREEN

Use the Player 1 START button to choose Game or Attract volume adjustment. When the selected variable flashes, use the joystick to change the level.

Game volume adjusts from zero to maximum. The game seems more realistic if players experience loud sounds during play. These weapons do not have silencers.

Attract volume is continuously adjustable from Mute (zero) to maximum. For greater profits, make Attract Mode loud to draw attention to Gauntlet: Dark Legacy Universal Conversion Kit.

You adjust Attract and Game volume levels independently, but Attract cannot be louder than Game volume. If you try this, Attract level automatically lowers proportionately. Lowering Attract level does not affect Game setting.

Volume level is represented a bar made of dots. The longer the bar, the higher the volume.

Press the Player 2 START button after making volume adjustments. The Player 1 START button cancels your recent changes and returns both levels to what they were before you touched them.

NOTE: These adjustments affect both the volume of the tests and game play. If the volume levels are set to minimum (zero), there will be no sounds from the speakers during any of the audio tests. Set the volume levels to a moderately high value when checking the game audio components and speakers. Return the levels to their previous settings after completing the tests.

STATISTICS

The Statistics report allows the operator to assess how well the game is being played. In addition to the earnings, various game aspects are tracked to determine the player skill levels.

Statistics may be reset to zero or allowed to increase after each viewing.

STATISTICS	
Left Coins	:0
Right Coins	:0
Service Credits	:0
1 Credit Games	:0
2+ Credit Games	:0
Idle Mins	:0
1 Player Mins	:0
2 Player Mins	:0
3 Player Mins	:0
4 Player Mins	:0
Number of Sessions	:0
Number of Join-Ins	:0
Total Game Starts	:0
Total Coins	:0
Average Time/Coin	:0
Percentage Play	:0
To clear these counters, Hold P1 START or TEST and press P2 START For more stats, Press P2 START or CREDIT	

STATISTICS REPORT MENU SCREEN

The illustration shows how the report screen looks after the game is reset or is first turned on. Most statistics increase in value as the game is played. It is normal for some values to remain at zero: for example, the Aux Coins count will not change unless an additional Currency Acceptor has been installed in the game, and the Error Count will not change if no errors have occurred.

Low counts in both coin and player statistics may suggest the game is too difficult for the skill levels of the players at this location; high continue counts may indicate the game is too easy. Difficulty level and other play characteristics may be adjusted from the Game Options menu.

Record statistics before performing service or making repairs on the game.

Press Player 2 START or service credit button to view system errors, which tell you the status of the hardware. Press Player 2 START again, and you will see user messages. Press Player 2 START again and you will see histograms. Press Player 2 START again to see level histograms.

Press both START buttons to cancel settings on screen and return all counts to factory default values.

The HISTOGRAMS screens will have no bar graphs until the system has enough data to plot.

The USER MSGS screen will contain no messages until the system detects an error.

GAME OPTIONS

These adjustments allow you to customize the game. Each variable changes an aspect of game appearance or play. Optimum settings cause high player interest and increase earnings.

Use the joystick to select a menu item and to view the range of choices or change their value. Options may be reset to factory defaults or changed after each viewing.

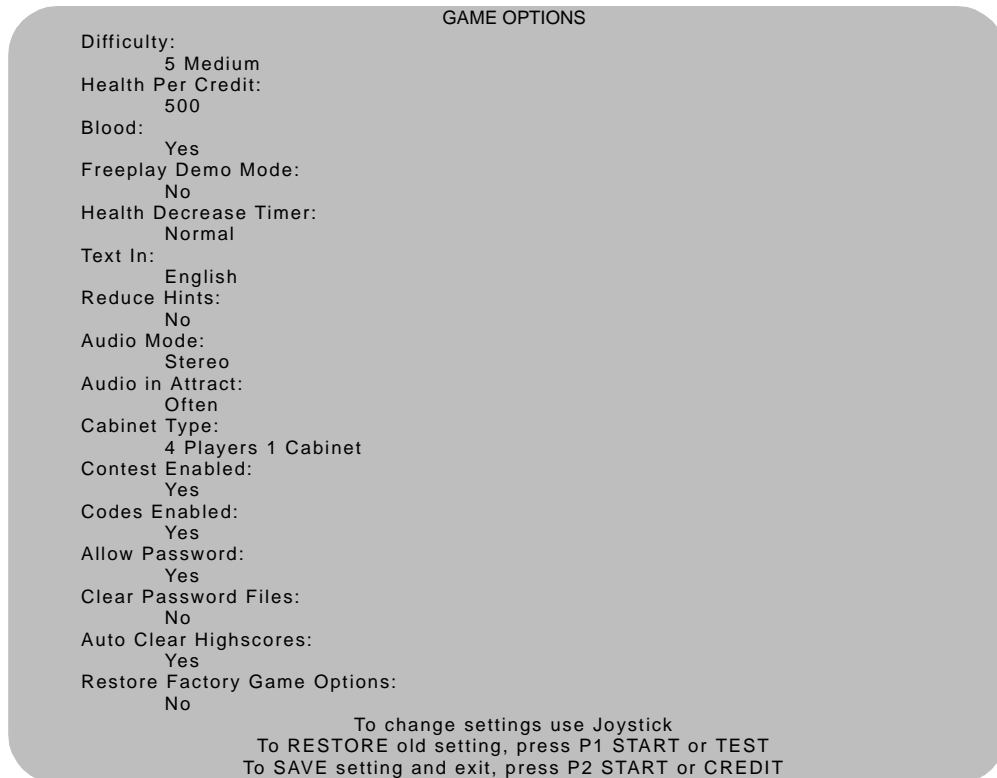

GAME OPTIONS MENU SCREEN

Factory defaults are displayed in green text.

The illustration shows how this report screen looks after game is reset or first turned on. Use joystick to advance variables through range of choices. Some items have more options than others. View all options before selecting one.

The effects of these options can be judged by comparing statistics reports before and after changes were made. As players become more familiar with the game, new features or increased difficulty will make the game challenging and continue to generate interest.

Difficulty adjusts the level of play difficulty. It ranges from easiest to hardest in several steps. Default is Medium.

Health Per Credit determines amount of health credits added to the timer each time a player uses a credit by pressing the START button. It ranges from 300 to 1000. Factory default is 500.

Blood controls whether blood and gore appear on screen when a character is killed. Factory default is Yes.

Freeplay Demo Mode increases the maximum number of health credits allowed on the health timer per game credit beyond normal game limits. Factory default is Off.

Health Decrease Timer sets the speed of the Health timer. It ranges from Off to Fast in several steps. Factory default is Normal.

Texts In selects the language of the on-screen announcements and hints. Selection of a different language changes the player information presented only on the screen. It does not change any of the voice announcements, menu screens or tests. Factory default is English.

Reduce Hints sets the frequency of visual and verbal assistance to a player during the game. Yes decreases the frequency of hints. Factory default is No.

Audio Mode sets the audio output of the game. Use Stereo for cabinets with more than one speaker. Use Mono for cabinets with a single speaker. Factory default is Stereo.

Audio in Attract sets the frequency of game play instructions while the game is idle and in attract mode. It ranges from Never to Always. Factory default is Often.

Cabinet Type configures the number and type of inputs for the cabinet. Factory default is 4 Players 1 Cabinet. You can also select one, two, or three Players.

Allow Password controls whether the game will save a player's character experience with a three-digit password for later games. Factory default is Yes. Take special caution before changing this setting, as many registered players invest much time and money into building up their characters, which can only be accessed with passwords.

Contest Enabled allows Midway sponsored T-shirt promotion. Players who defeat Garm by collecting all 13 rune stones and winning the final battle are eligible for an "I Beat Garm" T-shirt. Factory default is Yes.

Codes Enabled allows use of secret codes. Factory default is Yes

Clear Password files controls password file deletion. Set this feature to Yes to delete all saved character experience and passwords. Factory default is No.

Auto Clear Highscores sets whether the game will automatically reset the high score table from time to time. Factory default is No.

Restore Factory Game Options resets the Game Options. Set this option to Yes to reset the game to factory default options. Factory default is No.

Record the High Scores before making any option changes to the game.

NOTE: Changes to Game Difficulty or Number of lives automatically reset the Player High Scores, since these variables directly affect the ability to collect points .

COIN OPTIONS
PRICING OPTIONS

Use the Player 1 joystick to select menu items, view the range of choices, and change values. Options may be reset to factory defaults or changed after each viewing.

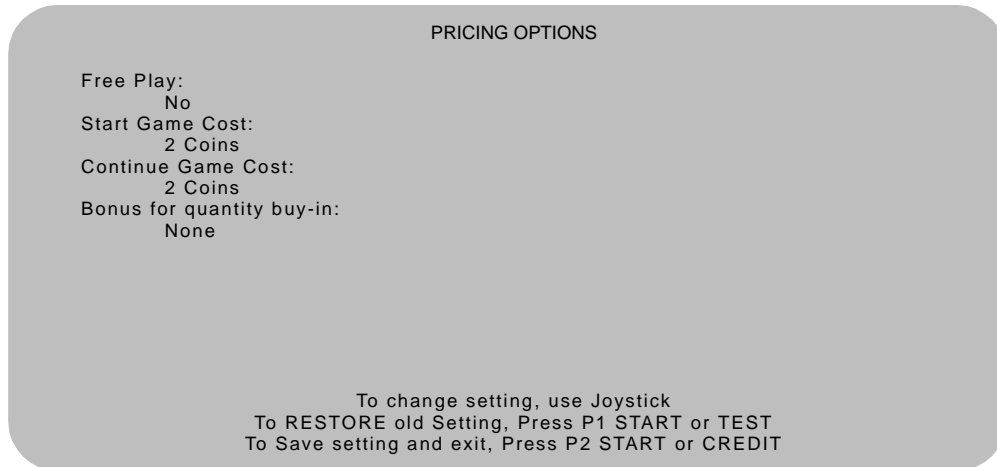

PRICING OPTIONS MENU SCREEN

Custom pricing sets credits required to start and continue a game, rewards for buy-in and winning, etc. Factory default are shown above. View all choices before selecting, as some items have more options than others. Free offers no options. Free game incentives may reduce earnings.

COIN OPTIONS

PRICING OPTIONS

Mech setup permits operators to add or remove coin or bill mechanisms. Values are shown for all devices, but changes to unused inputs have no effect if the mechanism is not in the game.

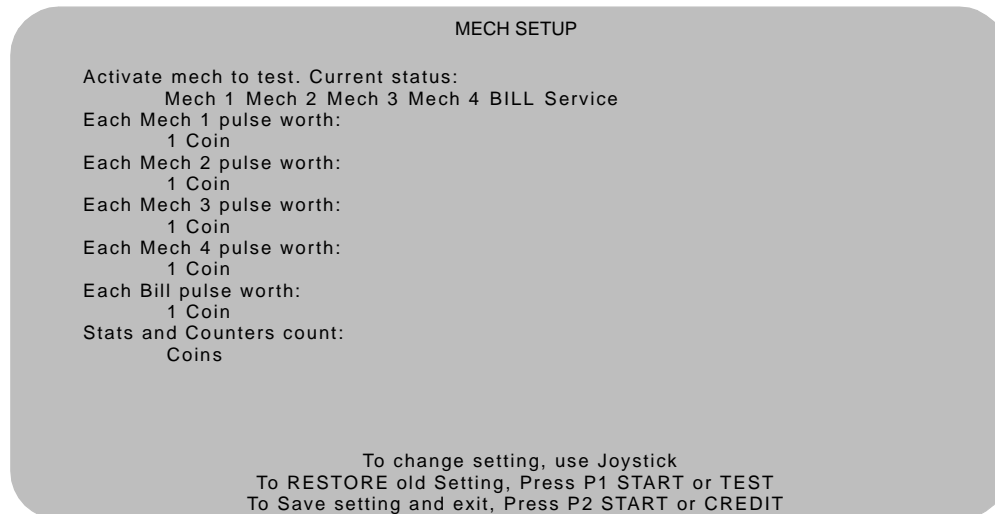

MECH SETUP MENU SCREEN

DIP SWITCHES

The two DIP switches located at U13 and U12 on the SIO Board configure the Electronics Assembly for various input and output devices. The on screen display shows the switch status for easy reference. See Wiring Chapter for specific information on the function of switch positions.

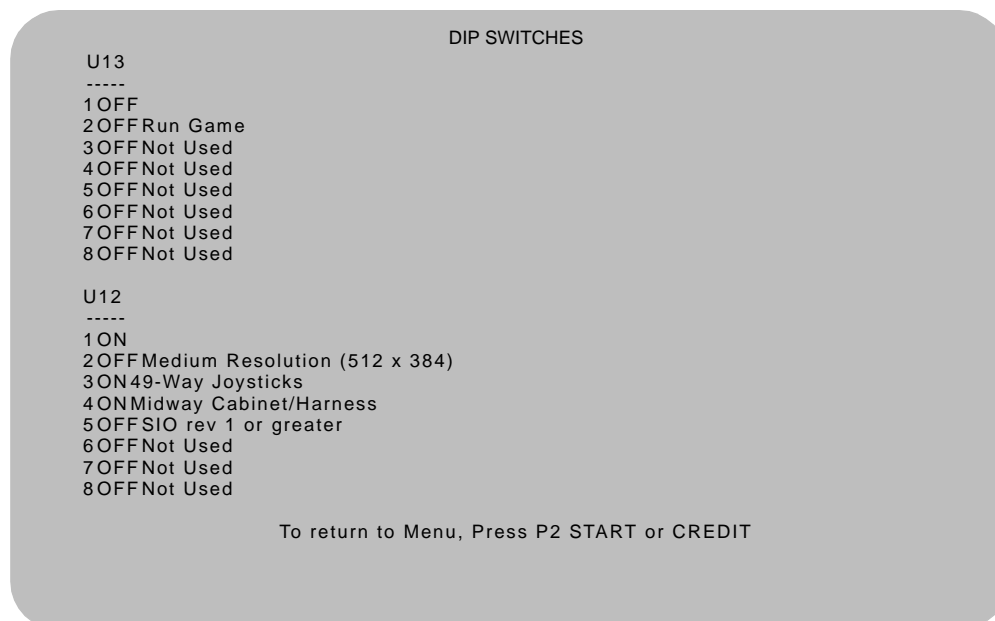

DIP SWITCH MENU SCREEN

CONTROLS TEST

These tests allow the operator to manually check each switch in the game.

	<p>NOTE. Some switches may not be used in Gauntlet: Dark Legacy Universal Conversion Kit. Check wiring diagram before testing.</p>
---	---

Use the joystick to select the Controls Test. Press Player 1 START button to begin test. Activate each switch and the indication on the screen changes state. Release the switch and the indicator returns to its previous normally open or closed condition. Test switches in any combination.

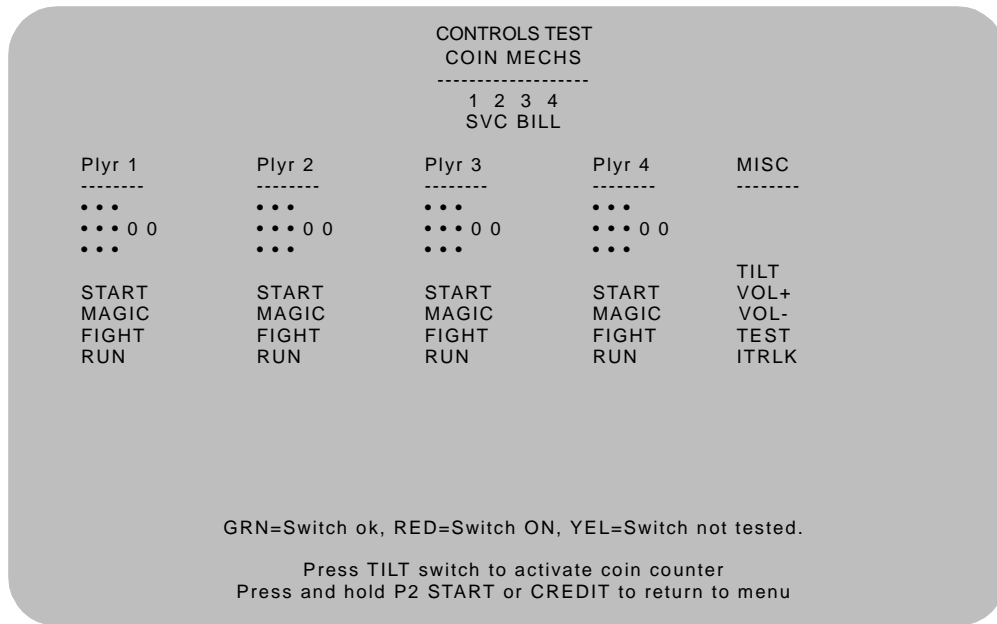

CONTROLS TEST MENU SCREEN

Each switch change should be exactly duplicated by a single indication on the menu screen. The alphanumeric indicators next to each joystick should display three distinct settings as the stick is moved in each direction toward its outermost limit.

Player Controls Tests verify crossed wires, intermittent conditions, and stuck switches.

OPERATOR CONTROLS are shown on screen under the MISC heading. Each switch change should be exactly duplicated by a single indication on the menu screen.

Operator Controls Tests verify crossed wires, intermittent conditions, and stuck switches.

Coin and Cabinet Switches are shown on the screen without regard for their actual game location. Each switch change should be exactly duplicated by a single indication on the menu screen.

SOUND TESTS

These tests verify the proper connection and operation of the audio components. There are no custom settings or variables in these tests, which are performed automatically.

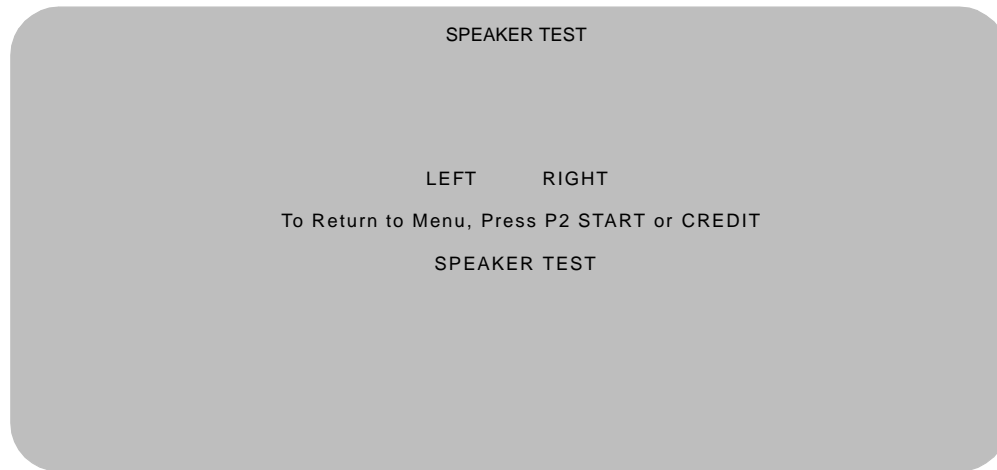

MENU SCREEN

SPEAKER TEST sends alternating voice sounds to the left and right speakers. Voices should be clear and distinct from each other. Each voice must come from the location identified. Refer to ADJUST VOLUME screen if necessary to increase loudness for this test.

The Speaker Test screen verifies crossed connections, incorrect phase, and distortion. Press the Player 2 START button to end the Audio Speaker Test and return to the SOUND TESTS menu.

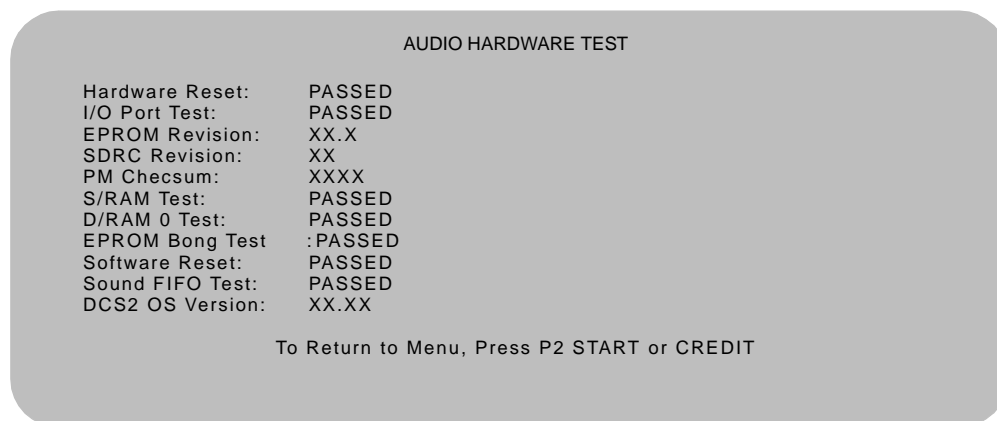

AUDIO HARDWARE TEST REPORT SCREEN

AUDIO HARDWARE TEST automatically tests the electronic components of the audio amplifier for problems and reports the results as "passed" or "failed." Each "failed" result should be noted and referred to qualified service personnel. This test also shows the revision numbers for the audio EPROMs and other components. Press SERVICE CREDIT to return to the SOUND refer to the Troubleshooting Chapter.

MONITOR TESTS

Monitor Tests provide patterns to verify monitor performance or make adjustments. Gauntlet: Dark Legacy Universal Conversion Kit uses a medium-resolution monitor. Other monitors may cause poor performance.

Use the joystick to select a menu item. Press the Player 1 START button to begin the test. Once the menu is open, use the joystick to select an option, and the Player 1 START button to begin it. Use the Player 1 START button to select various elements of each test. Press the Player 2 START button to return to the Monitor Tests menu screen.

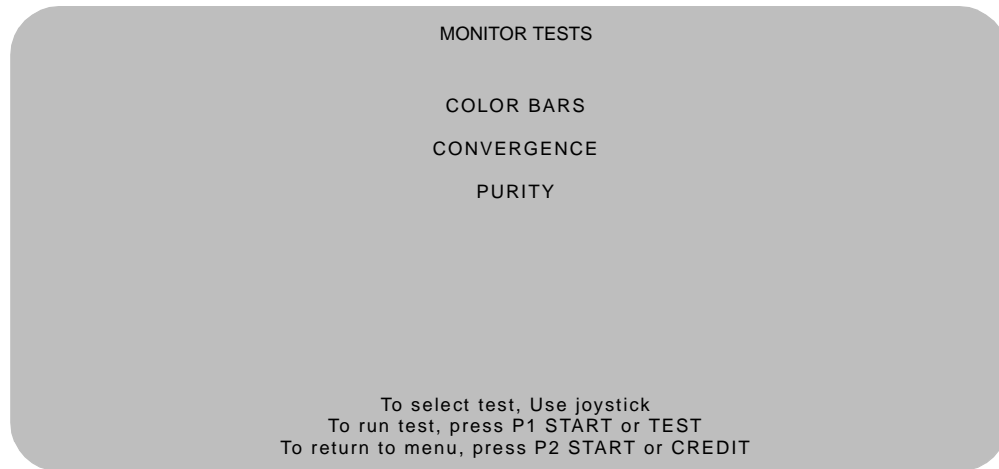

MONITOR TESTS MENU SCREEN

COLOR BARS fills the screen with shades of colors to verify red, green, blue and white level dynamic adjustments. Each bar should appear sharp, clear, and distinct from bars on either side.

Borders must be visible on top, bottom, and sides of screen. Bars should not change screen position or color as the background or border are removed or restored from the video display.

Color Bars screen is useful in adjusting the monitor brightness and contrast.

CONVERGENCE tests fill the screen with a grid and a series of dots. Grid and the dots should be all one color, with no fringes or parallel images. Lines should be straight and dots round.

Borders must be visible on top, bottom, and sides of screen. Lines and dots should not change position or color as background or border are removed or restored from video display.

Convergence tests are useful in verifying the monitor convergence, linearity, and dynamic focus.

PURITY tests fill the screen with 100% of the chosen color at normal intensity. Each screen should be uniform from top to bottom and side to side. No retrace lines or noise should be visible.

Borders must be visible on top, bottom, and sides of screen. Image color should not change position or color as the background or border are removed or restored from the video display.

Purity tests help verify monitor intensity, black level, blanking and automatic degaussing.

DISK TESTS

These verify Hard Disk Drive functions. Some files can be repaired. These tests are automatic and the results appear on the menu screen as they occur. There are no custom settings or adjustable variables in these tests. The Player 2 START button aborts the tests.

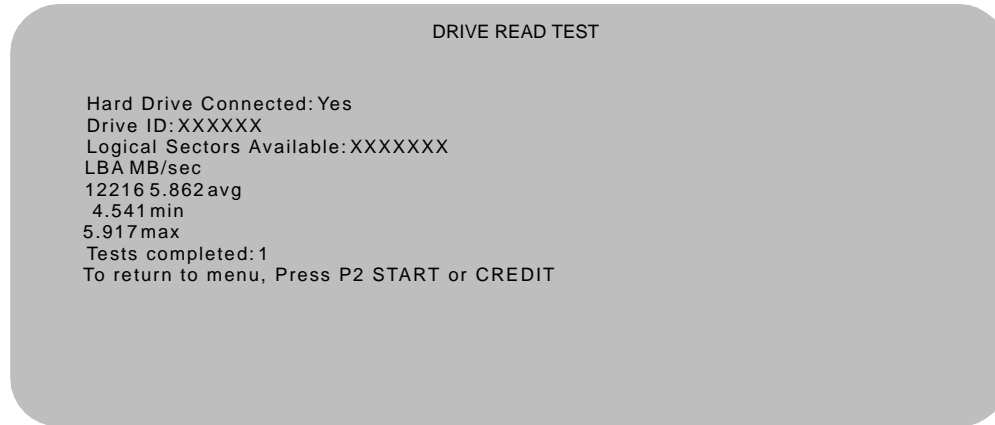

DRIVE READ TEST MENU SCREEN

Hard Drive Connected test verifies interface between CPU Board Assembly and Hard Disk Drive. The processor requests disk information. Data cannot be retrieved if there is a problem.

Drive ID is an industry standard identification for Hard Disk type and capacity. This is a manufacturer hardware number only; it does not identify software or program stored on drive assembly.

Logical Sector Test performs a sector by sector read/verify test on the drive. As the status of each block of sectors is checked, the speed of data transfer is compared to its acceptance limits.

Tests Completed These tests run over and over. The number increases each time the test cycle repeats (approx. every 5 minutes). After at least one cycle ("pass") is complete, note any errors and press the Player 2 START button to end the test.

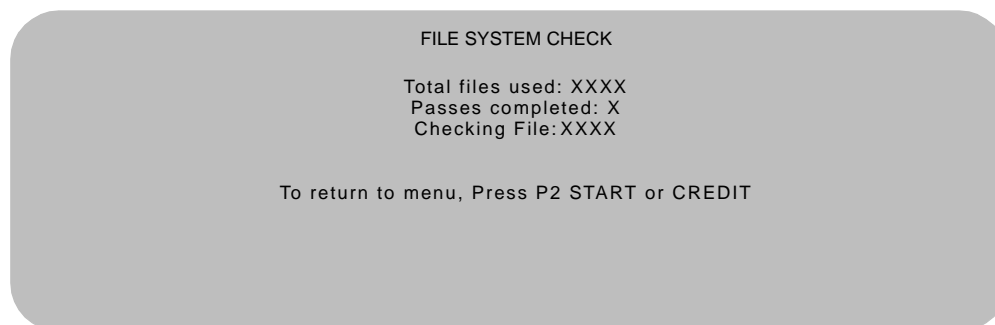

FILE SYSTEM TEST SCREEN

Checking File performs a file by file check of data stored on the hard disk drive and reports its findings. If there are errors, the system tries to fix them (approx. 5 minutes per cycle). The system reports on the severity of the errors and advises if they will affect game performance.

SET RTC

Use this menu to set the correct time and date for your location.



SET RTC MENU SCREEN

SWITCHES AND JUMPERS

The CPU and Sound I/O Boards have several hardware variables that can be changed to adapt this assembly to other uses. Jumpers activate circuit paths, and DIP switches select instructions.

Switches

There is one pushbutton switch on the CPU Board Assembly. It resets the CPU Board and restarts the game without turning off the power supply. There are two DIP switches on the Sound I/O Assembly at U12 and U13. See Wiring Chapter for further explanation.

Jumpers

Jumpers control signals to other components in this game. These signals match production audio amplifiers, speaker system, and video monitors.

Active circuit paths are factory optimized during the board test procedure. Leave jumpers in original positions to avoid program error messages.

Errors

The system detects errors at startup or during diagnostic tests and reports them on screen. The system automatically repairs errors such as minor disk data faults. Fix other errors, such as player control calibration, by manually resetting values in game memory. Gauntlet: Dark Legacy Universal Conversion Kit generally continues to operate (but with reduced performance) after discovering minor errors.

Record error messages before attempting to correct a problem. The USER MESSAGES report may store additional temporary messages (refer to STATISTICS earlier in this chapter).

After recording messages, turn off AC power, wait a few minutes, then turn AC power on. Pay attention to the startup screens and note any error messages during Power On Self Tests. If possible, enter the SELF TEST MENU SYSTEM and run all tests related to where errors occurred. Record and compare any new messages to the previous ones to determine whether errors are random or chronic.



NOTICE. Do not ignore error messages even if you can start and operate the game. Poor performance caused by playing games with errors may reduce earnings.

GAUNTLET DARK LEGACY

CHAPTER

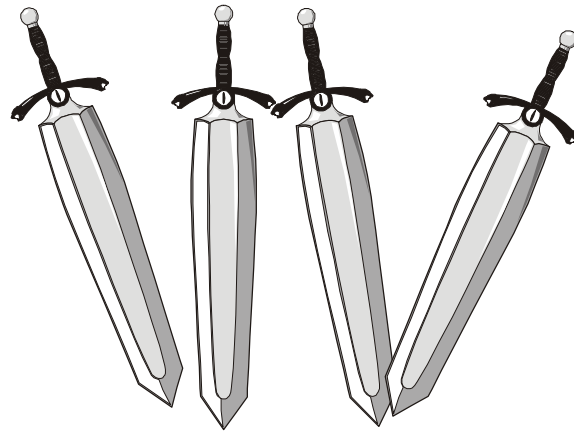

Wiring



NOTICE: Information in this manual may change without notice. Midway Games West Inc. reserves the right to make improvements in equipment function, design, or components as progress in engineering or manufacturing methods may warrant.

EDGE CONNECTOR CHART

FUNCTION	WIRE COLOR	PIN	PIN	WIRE COLOR	FUNCTION
Ground	Black	A	1	Black	Ground
Ground	Black	B	2	Black	Ground
+5VDC	Red	C	3	Red	+5VDC
+5VDC	Red	D	4	Red	+5VDC
-5VDC	Yellow	E	5	Yellow	-5VDC
+12VDC	Orange	F	6	Orange	+12VDC
Key	N/C	H	7	N/C	Key
Coin Counter 2	Brown-Red	J	8	Brown	Coin Counter 1
Not Used	N/C	K	9	N/C	Not Used
Speaker -, Left	Brown-Gray	L	10	Red-Gray	Speaker +, Left
Speaker +, Right	Brown-White	M	11	Red-White	Speaker-, Right
Video Green	Yellow-Green	N	12	Yellow-Red	Video Red
Video Sync	Yellow-White	P	13	Yellow-Blue	Video Blue
Service Credits	White-Gray	R	14	Yellow-Black	Video Ground
Slam Tilt	Black-Green	S	15	Black-Blue	Test
Coin 2	Black-Red	T	16	Black-Brown	Coin 1
Player 2 Start	Violet-White	U	17	White	Player 1 Start
Player 2 Up	Violet-Black	V	18	White-Black	Player 1 Up
Player 2 Down	Violet-Brown	W	19	White-Brown	Player 1 Down
Player 2 Left	Violet-Red	X	20	White-Red	Player 1 Left
Player 2 Right	Violet-Orange	Y	21	White-Orange	Player 1 Right
Player 2 Fight	Violet-Yellow	Z	22	White-Yellow	Player 2 Fight
Player 2 Magic	Violet-Green	a	23	White-Green	Player 1 Magic
Player 2 Run	Violet-Blue	b	24	White-Blue	Player 1 Run
Not Used	N/C	c	25	N/C	Not Used
Not Used	N/C	d	26	N/C	Not Used
Ground	Black	e	27	Black	Ground
Ground	Black	f	28	Black	Ground
SOLDER SIDE			COMPONENT SIDE		

Joystick control wires that are not part of the main JAMMA Harness

Ground	Black	1	1	Black	Ground
Not Used	N/C	2	2	N/C	Not Used
Not Used	N/C	3	3	N/C	Not Used
Key	N/C	4	4	N/C	Key
Not Used	N/C	5	5	N/C	Not Used
Player 3 Start	Blue-White	6	6	Blue-White	Player 4 Start
Player 3 Up	Blue-Black	7	7	Blue-Black	Player 4 Up
Player 3 Down	Blue-Brown	8	8	Blue-Brown	Player 4 Down
Player 3 Left	Blue-Red	9	9	Blue-Red	Player 4 Left
Player 3 Right	Blue-Orange	10	10	Blue-Orange	Player 4 Right
Player 3 Fight	Blue-Yellow	11	11	Blue-Yellow	Player 4 Fight
Player 3 Magic	Blue-Green	12	12	Blue-Green	Player 4 Magic
Player 3 Run	Blue	13	13	Blue	Player 4 Run
Not Used	N/C	14	14	N/C	Not Used

DC Power Source Voltage Limits

Function	Range Limits	Color	Function	Range Limits	Color
Digital Circuits	+4.90V to +5.10V	Red	Coin	-4.75V to -5.25V	Yellow
Audio, Lights	+11.5V to +12.5V	Orange	Aux Power	-11.5V to -12.5V	Blue

MAIN CABINET WIRING DIAGRAM

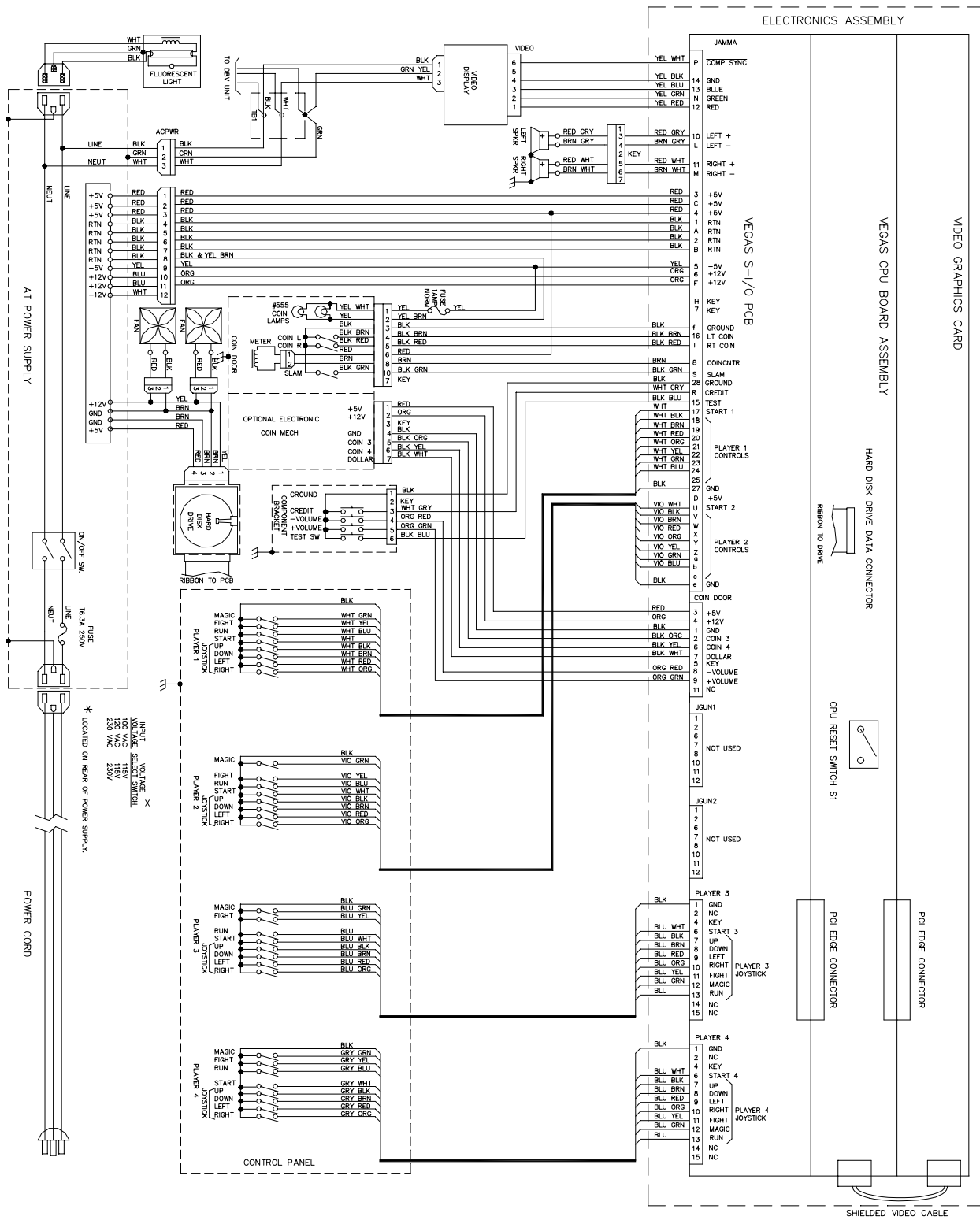

VEGAS CPU BOARD ASSEMBLY

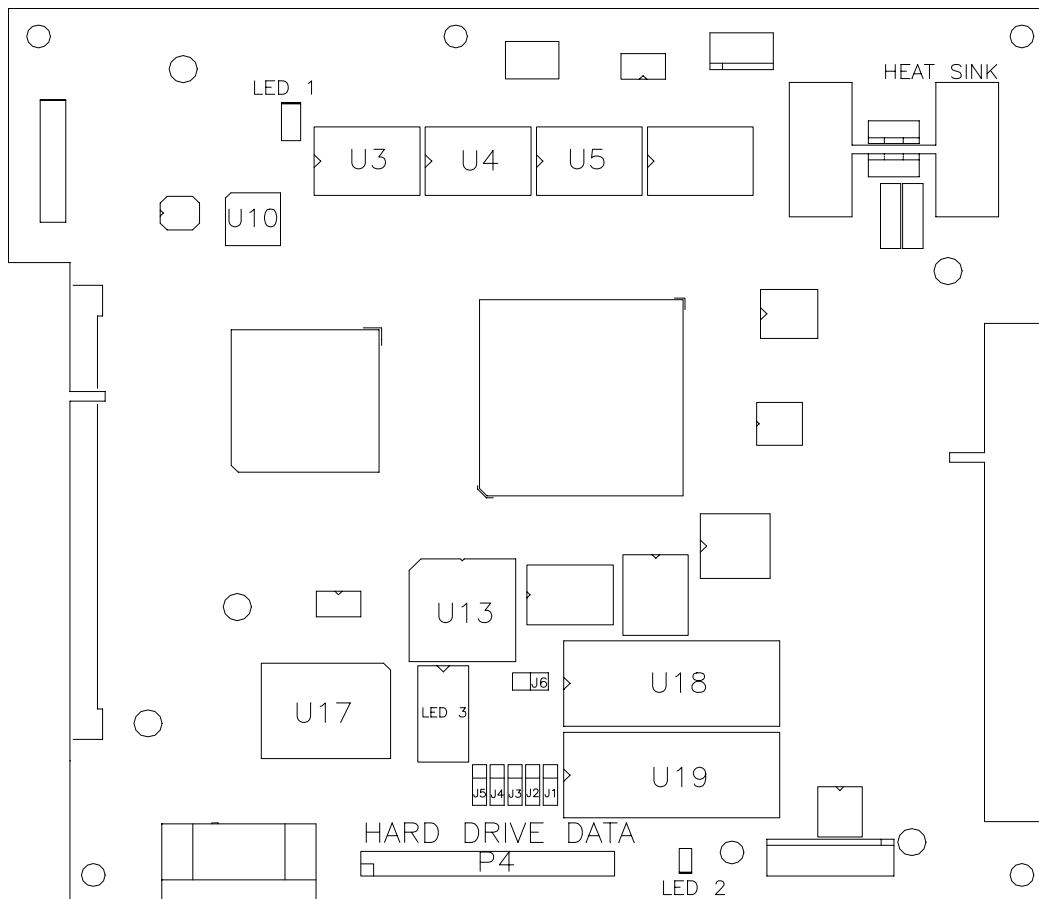

VEGAS CPU ASSEMBLY SWITCH

Designation	Location	Function	Positions	State	Meaning
S1	Edge near U4 and U5	Resets and Restarts Game	2	Off	Normal Operation
				On	Forced Reset

Note: This switch resets the CPU Board without turning the power off at the power supply.

VEGAS CPU BOARD ASSEMBLY JUMPER POSITION CHART

Designation	Location	Function	Meaning	Position	Default
J1 (Note 1)	Near U19 & Connector P4	CPU Boot ROM Type (U18)	EPROM	Pins 1 & 2	X
			Flash ROM	Pins 2 & 3	
J2 (Note 2)	Near U19 & Connector P4	CPU Boot ROM Size (U18)	1, 2, or 4Mbit flash ROM	Pins 1 & 2	X
			8 Mbit flash ROM	Pins 2 & 3	
J3 (Note 1)	Near U19 & Connector P4	CPU Boot ROM Type	EPROM	Pins 1 & 2	X
			Flash ROM	Pins 2 & 3	
J4 (Note 2)	Near U19 & Connector P4	CPU Boot ROM Size (U18)	2Mbit ROM	Pins 1 & 2	X
			1Mbit ROM	Pins 2 & 3	
J5 (Note 3)	Near U19 & Connector P4	Expansion Boot ROM Size (U19)	4Mbit ROM	Pins 1 & 2	X
			8Mbit ROM	Pins 2 & 3	
J6	Between U13 & U18	Boot Program Location	Boot from CPU ROM	Pins 1 & 2	X
			Boot from SIO ROM	Pins 2 & 3	

Note 1: Set both jumpers J1 and J3 to EPROM or Flash ROM mode to use such devices.

Note 2: These jumpers are independent

Note 3: This jumper is independent of the CPU boot ROM size selected

VEGAS CPU BOARD ASSY LED INDICATOR STATUS CHART

Designation	Location	Function	Color	State	Meaning
LED1 (Note 1)	Near U3 & U10	3.3V CPU Power Indicator	Red	Off	Insufficient Power
				On	Power OK
				Blinking	Power Fault
LED2 (Note 2)	Near U19 & Connector P4	Hard Disk Drive Activity	Green	Off	Not in use
				On	Locked Up
				Blinking	Normal disk activity
LED3 (Note 3)	Near U13 & U17	Indicator	Red	Off*	*See Note Below
				On*	
				Blinking* Sequentially	

Note 1 LED1 monitors CPU power (+3.3 Volts). If this LED is off or blinking, investigate processor circuits. If other LEDs are off or blinking at the same time, check the +5 Volt circuits or game power supply.

Note 2 LED2 flashes when hard disk operates during game play. It may light continuously during startup. If this LED lights continuously, there may be a fault with the hard disk drive, which may be locked up.

Note 3 LED3 initially indicates program start-up stages. It is a seven-segment alphanumeric display device. Under normal conditions, it displays a lowercase "b" or a sequentially blinking segment in an "O" pattern. During any of the self-test screens, it displays a "bouncing bar" resembling a hyphen ("-").

VEGAS SOUND I/O ASSEMBLY

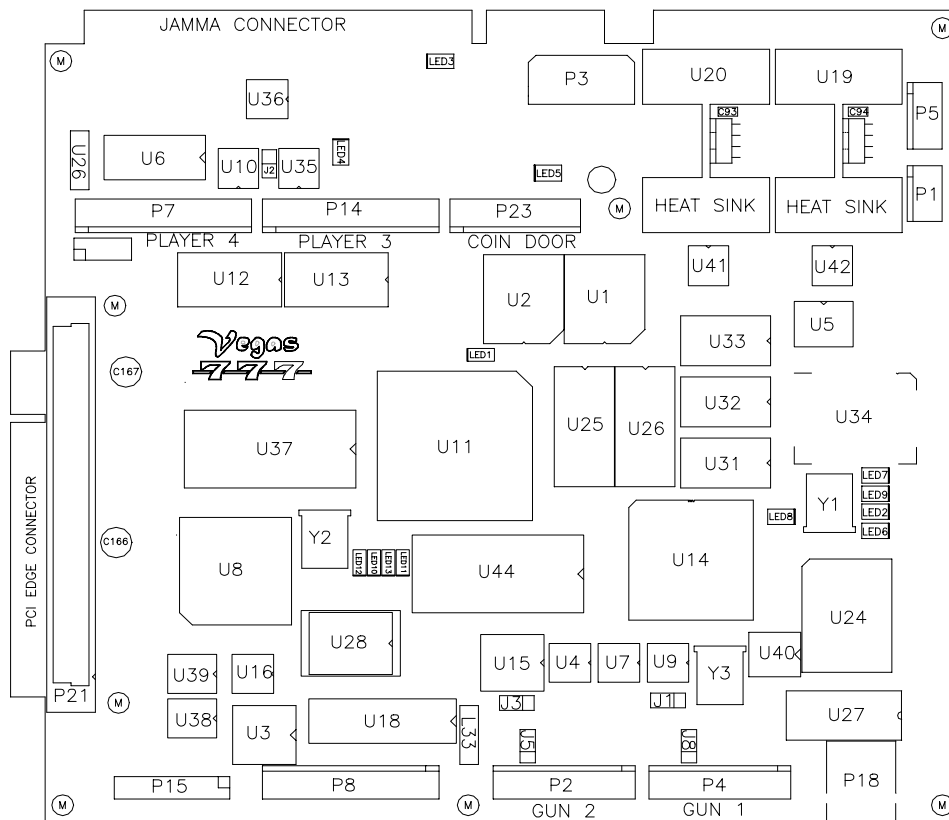

VEGAS SOUND I/O BOARD ASSY JUMPER POSITION CHART

Designation	Location	Function	Meaning	Position	State
J1 (Note 1)	Near U9 & Crystal Y3	Gun 1 I/O Connector P2	Input Mode	Pins 1 & 2	X
J2			Output Mode	Pins 2 & 3	
	Between U35 and U10	Video Sync	Positive Sync	Jumper Not Installed	X
J3 (Note 2)	Near U15	Gun 2 I/O Connector P4	Negative Sync	Pins 1 & 2	
			Input Mode	Pins 1 & 2	X
			Output Mode	Pins 2 & 3	
J4	None	None	Not Used	None	---
J5 (Note 2)	Between U15 & Connector P2	Gun 2 I/O Connector P4	Input Mode	Pins 1 & 2	X
			Output Mode	Pins 2 & 3	
J6	None	None	Not used	None	---
J7	None	None	Not Used	None	---
J8 (Note 1)	Between U9 & Connector P4	Gun 1 I/O Connector P2	Input Mode	Pins 1 & 2	X
			Output Mode	Pins 2 & 3	

Note 1 Set Gun 1 (P2) I/O port by setting both J1 and J8 jumpers to input or output mode.

Note 2 Set Gun 2 (P4) I/O port by setting both J3 and J5 jumpers to input or output mode.

VEGAS SOUND I/O BOARD ASSEMBLY LED INDICATOR STATUS CHART

Designation	Location	Function	Color	State	Meaning
LED1	Near U11	SIO Board Activity	Green	Off	No boot ROM
				On	SIO Board locked up
				Blinking	Power Fault
LED2	Near U34 Crystal Y1	Linking Connector Status	Green	Off	Not in use (no game linking)
				On	Normal Linked Operation
				Blinking	Link Fault
LED3	Near the Jamma Connector	-5V Power indicator	Red	Off	No power
				On	Normal operation
				Blinking	Power fault
LED4	Near U35 & Connector P14	+12V Power indicator	Red	Off	No power
				On	Normal operation
				Blinking	Power fault
LED5	Near Connector P23	+5V Power indicator	Red	Off	No power
				On	Normal operation
				Blinking	Power fault
LED6	Near U34 & Crystal Y1	CPU Linking Activity	Red	Off	Not in use
				On	CPU linking in progress
				Blinking	Normal operation
LED7	Near U34 & Crystal Y1	Linking Data	Red	Off	Not in use (no game linking)
				On	Sending data
				Blinking	Normal operation
LED8	Near U14 & Crystal Y1	Audio Activity	Yellow	Off	No sound boot ROM
				On	Locked up
				Blinking	Normal operation
LED9	Near U34 & Crystal Y1	Linking Receiving data	Yellow	Off	Not in use (no game linking)
				On	Receiving data
				Blinking	Normal operation
LED10	Near U44 & Crystal Y2	Audio activity	Green	Off	Not in use (no audio data)
				On	Receiving data
				Blinking	Normal operation
LED11	Near U44 & Crystal Y2	None	Red	Off	Not in use (normal)
				On	Circuit fault
				Blinking	Circuit fault
LED12	Near U44 & Crystal Y2	Interrupt activity	Yellow	Off	Not in use (no interrupts)
				On	Receiving data
				Blinking	Normal operation
LED13	Near U44 & Crystal Y2	Disk Activity	Yellow	Off	Not in use
				On	Processing data
				Blinking	Normal operation

VEGAS SOUND I/O ASSEMBLY DIP-SWITCH SETTINGS

Service technicians may change DIP-switches with AC power on. “*” indicates factory defaults.

DIP Switch U12		SW1	SW2	SW3	SW4	SW5	SW6	SW7	SW8
Monitor resolution	Standard Medium	Off On*							
Monitor Style	Video Game VGA		Off* On						
Joystick Type	8-Way 49-Way			Off* On					
Switch Condition	Normally Closed Normally Open				Off On*				
Vegas Sound I/O Board Version	Revisions 1 to 5 Revisions 6+					Off On*			
Not Used							Off* On		
Not Used								Off* On	
Not Used									Off* On

DIP Switch U13		SW1	SW2	SW3	SW4	SW5	SW6	SW7	SW8
Display Comments on VT100	No Yes	Off* On							
Diagnostic Code Source	Hard Disk Drive EPROM		Off* On						
Not Used				Off* On					
Not Used					Off* On				
Not Used						Off* On			
Not Used							Off* On		
Not Used								Off* On	
Not Used									Off* On

GAUNTLET DARK LEGACY

CHAPTER

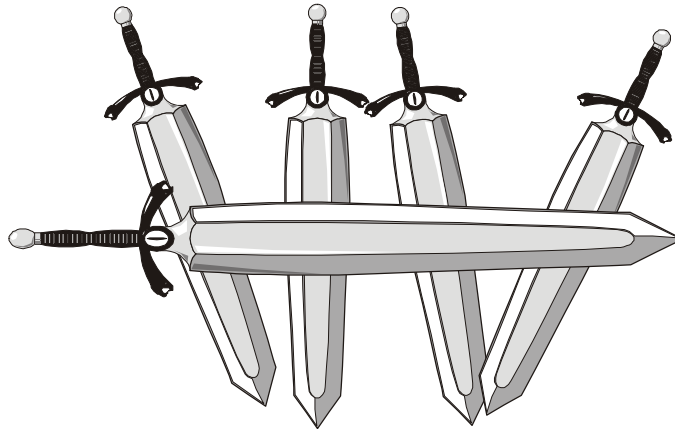

Troubleshooting



NOTICE: This Chapter only covers repair of items included in conversion kit. For information on repairing or maintaining original components, please refer to original manual.

Game Does Not Start

Symptom	Problem	Suggested Solution
<ul style="list-style-type: none"> Machine appears non-functional No audio Machine appears non-functional. Currency acceptor price indicator is illuminated 	Lack of electricity	<ol style="list-style-type: none"> 1. Check that Power Switch has been turned on 2. Verify that line cord is plugged fully into receptacle and into power supply. 3. Try another power outlet.
	Faulty AC line filter	<ol style="list-style-type: none"> 1. Inspect board assemblies under low light level conditions. A glow will be seen from the Light Emitting Diodes if there is voltage in the processor circuits. This does not mean that voltages or signals are as they should be, but it indicates that boards are receiving some DC power from power supply. The power supply fan should also be operating. 2. Turn AC power off. Inspect board assemblies. Ensure JAMMA wire harness connector is attached and fully seated onto mating board connector. Check other wiring harness connectors in same way. 3. Verify game switches and jumpers are set correctly. Refer to Board Configuration Chart for variables and default settings.
		<ol style="list-style-type: none"> 1. Turn AC power on. Using 20V DC setting on digital voltmeter, measure voltages at power connector pins. Adjust +5V source if necessary. Refer to Cabinet Wiring Diagram for specific wiring information and voltage limits. 2. Using 2V AC setting on digital voltmeter, measure same DC voltages as above. A reading indicates that supply voltages are unstable and may contain ripple or noise.

Game cannot be played

Symptom	Problem	Suggested Solution
<ul style="list-style-type: none"> Game does not accept currency or tokens. Game does not start. Audio present Video present 	Incorrect software setting	<ol style="list-style-type: none"> 1. Enter Menu System by pressing TEST MODE switch. From SELF TEST menu, choose COIN OPTIONS. Confirm pricing and setup of each mechanism. 2. Choose CONTROL TESTS to check operation of each coin or bill mechanism.
<ul style="list-style-type: none"> Bill validator fails after field installation. Coin mechanisms operate properly. 		<ol style="list-style-type: none"> 1. Enter Menu System by pressing TEST MODE switch. From SELF TEST menu, choose COIN OPTIONS. Confirm pricing and setup of each mechanism. Check validator switch settings against manufacturer's instructions. 2. Check illumination of external coin door indicators (i.e., pricing, flashing arrows). Free parts or wires caught in hinges, latches, or switch contacts. Verify seating of harness connectors. Check validator cable continuity. 3. Place bill validator in known good unit to verify operation.

Symptom	Problem	Suggested Solution
<ul style="list-style-type: none"> • Game accepts currency or tokens. • Game does not start. • Audio present • Video present. 		<ol style="list-style-type: none"> 1. Ensure proper mounting of each mechanism. Verify each release latch is closed and locked. Test acceptance and rejection functions with known good and bad coins. 2. Ensure no loose parts or wires are caught in hinges, latches, or switch contacts. 3. Inspect illumination of external coin door indicators (i.e., pricing, flashing arrows). Check wiring continuity of connectors and cables from CPU Board to coin mechs. 4. Enter Menu System by pressing TEST MODE switch. From SELF TEST menu, choose COIN OPTIONS. Use tests to confirm pricing and setup of each mechanism. 5. Check for continuity in each suspect switch connection (Common to Normally Open or Common to Normally Closed) Replace faulty switches (bent levers, broken actuators, etc.) 6. Place coin mechs in known good unit to verify operation.

Audio Problems

<ul style="list-style-type: none"> • Audio non-functional. • Video present. • Game operates normally. 	Volume set too low	<ol style="list-style-type: none"> 1. Press TEST MODE switch to enter Menu System. From SELECT TEST menu, choose ADJUST VOLUME. Verify that attract and game volume levels are not set to zero. Change to appropriate levels. 2. Return to previous menu and choose SOUND TESTS. Verify operation of each speaker.
<ul style="list-style-type: none"> • Audio muffled, distorted, or missing frequencies. • Constant, low hum. 	Faulty speaker	<ol style="list-style-type: none"> 1. Press TEST MODE switch to enter Menu System. From SELECT TEST menu, choose SOUND TESTS. These verify some audio functions. 2. Using 2 volt AC setting on digital voltmeter, measure voltages at speaker terminals. Any reading here indicates supply voltages are unstable and may contain ripple or noise. 3. Place speaker in good machine to verify operation.

Video Problems

Symptom	Problem	Suggested Solution
<ul style="list-style-type: none"> • Power-up self test runs. • Game does not appear. • No audio. 	Error message	Record error messages. Press TEST switch to enter menu system. From SELECT TESTS menu, choose DISK TESTS. These tests verify hard disk drive functions.
	Faulty hard disk drive	<ol style="list-style-type: none"> 1. Turn off AC power. Unlock and open front door. Ensure hard disk cable connector is fully seated on CPU Board. Ensure all hard drive mounting screws are installed. 2. Ensure hard disk, ROM set and CPU Board Assembly are correct part for game. Each component is labeled with the assembly number and software or hardware version.

Miscellaneous

Symptom	Problem	Suggested Solution
<ul style="list-style-type: none"> • Game resets randomly. 		<ol style="list-style-type: none"> 1. Check fan assemblies on CPU Board Assembly. Ensure fans are connected to power sources. 2. Check cabinet and Electronics Assembly ventilation holes for obstructions. 3. Clear obstructions and allow ventilation holes access to fresh air.
<ul style="list-style-type: none"> • Error messages appear. • Game does not start. • No audio. 		<ol style="list-style-type: none"> 1. Check any assembly identified in error message. 2. Call your authorized distributor for help with unresolved screen messages.